

MYSTERY  
RANCH®



OUTDOOR  
WORKBOOK

24



## OUTDOOR PRODUCTS SPRING 2024

FRAMES, TECHNOLOGY & MATERIALS	4
BACKPACKING PACKS	6
TERRAFRAME SYSTEM	8
HIKING PACKS	14
ENDURANCE YOKE	16
CLIMBING PACKS	40
SNOW PACKS	46
EVERYDAY CARRY	52
TRAVEL	80
WATERPROOF	88
ACCESSORIES	96
LOGOWEAR	104
FITTING & SIZING	120
WARRANTY & REPAIRS	121



BUILT FOR  
THE  
MISSION®

Born in the northern Rocky Mountains of Montana, MYSTERY RANCH has designed and built bombproof backpacks for over 40 years. Inspired by our outdoor obsessions — wilderness backpacking, peak bagging, rock and ice climbing, backcountry skiing — as well as our zeal for far-flung travel — here you'll find our latest, most dialed Mountain collection.

For much of the past 20 years, we've developed Load Carriage™ systems for the most demanding customers and environments out there: military combat and wildland firefighting. These high-level users came to us because they knew of our pack-engineering pedigree. They needed purpose-built packs that would carry monstrous loads with more stability — packs that would endure relentless hammering in the field without failure... year in and year out. Designing for this professional and industrial user has taught us about building functional, comfortable packs for hikers, backpackers, climbers, skiers, hunters, and other outdoor zealots.

With a heritage rooted in mountain sports, we're psyched to come full circle. Our goal is to partner with outdoor specialty shops whose customers demand the most evolved, proven, load-bearing designs. With so much commodity product on the market, MYSTERY RANCH packs distinguish themselves with active suspension systems and only the highest quality durable fabric and trim packages. Designed and built to endure the long haul — and then some.

**MYSTERY RANCH® — BUILT FOR THE MISSION®**



# FRAMES & TECHNOLOGY

---

## **GUIDE LIGHT MT™** FRAME

### GUIDE LIGHT MT™ FRAME

The patented **GUIDE LIGHT MT™ FRAME** continues the load carriage tradition with its rigid yet dynamic frame system. Utilizing custom-developed SJ Autolock buckles and 500D Light Plus **CORDURA®** fabric in combination with the five-point waistbelt, this frame delivers strength and durability regardless of the load.

---

## **FUTURA** YOKE

### FUTURA YOKE SYSTEM

The patented **MYSTERY RANCH Futura Yoke** system enables you to micro-adjust the torso length, making it a crucial piece of the pack's structure.

---

## **OVERLOAD®** FEATURE

### OVERLOAD® FEATURE

The patented **OVERLOAD®** feature provides functional expandability via a load sling between the pack and the frame, allowing you to put the bulk of the weight closest to your back for optimal comfort.

# MATERIALS

---

**CORDURA®**

CORDURA® fabrics

---

**CORDURA®**  
*re/cor™*

CORDURA® Re/Cor™ fabrics  
Expect More, Waste Less.

---

**YKK®**

YKK® Zippers

---

MIPAN  
**regen robic**

**Regen Robic**  
RECYCLED ROBUST RESILIENT  
Recycled high-tenacity nylon



# BACKPACKING PACKS

**MYSTERY RANCH** has designed  
and built bombproof backpacks  
for decades.

Big trips and monster loads require intelligently engineered load-bearing designs. Good thing our backpacks distill over 40 years of field-tested, finely tuned Load Carriage™ wisdom.





# GO AHEAD, BRING MORE!

## TERRAFRAME SYSTEM

The TERRAFRAME SYSTEM features patented MYSTERY RANCH technology that increases capacity. The bag removes from the frame, exposing the load shelf and allowing you to compress additional gear and awkward-shaped loads for comfortable carry over long distances. This intelligently engineered load-lifting frame and harness technology gives you the edge over gravity.

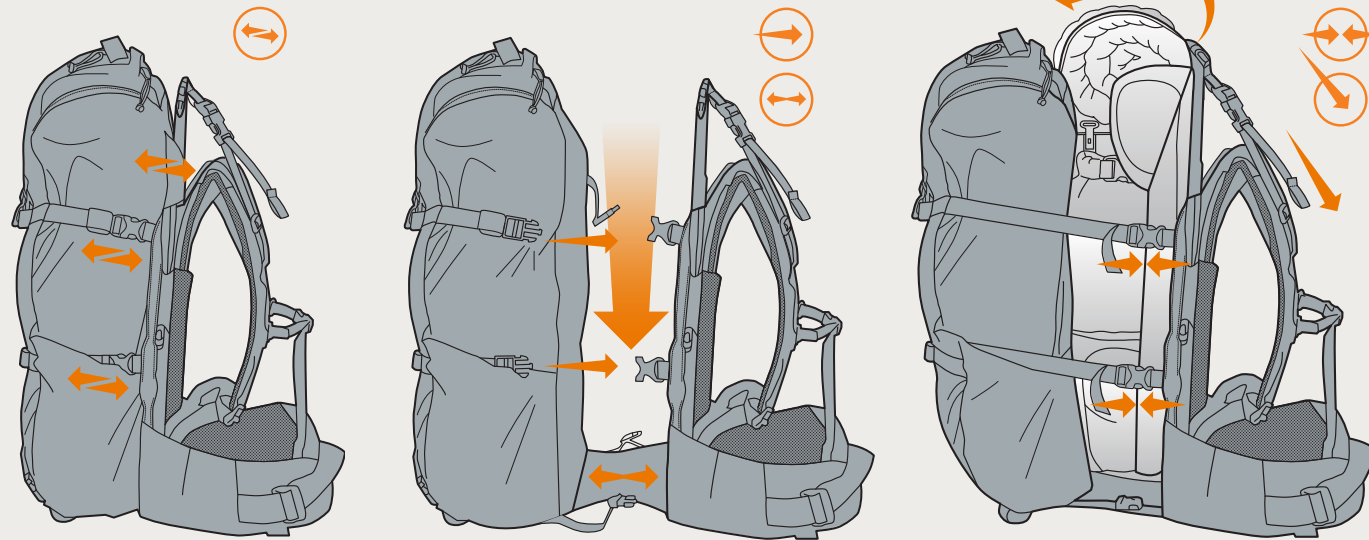

Release

Expand & Load

Reconnect & Compress



Look for packs with the OVERLOAD® feature icon.



# TERRAFRAME 80

An expandable load hauler for your biggest mountain adventures. With torsional flex that provides support for loads up to 150 lbs without crushing your back, yeah, **BRING MORE!**

## KEY FEATURES:

- 1 Convertible Daypack Lid with porting for hydration
- 2 Two external long pockets for rapid access
- 3 Stretch-woven water bottle pockets and hydration reservoir-compatible
- 4 Daisy chain with adjustable tool attach loop
  - Top-loading shroud with full-bag zippered panel access around back pockets
  - Quick-attach frame cap hardware provides easier OVERLOAD® feature
  - Telescoping yoke for custom torso fit
  - Hydration reservoir compatible

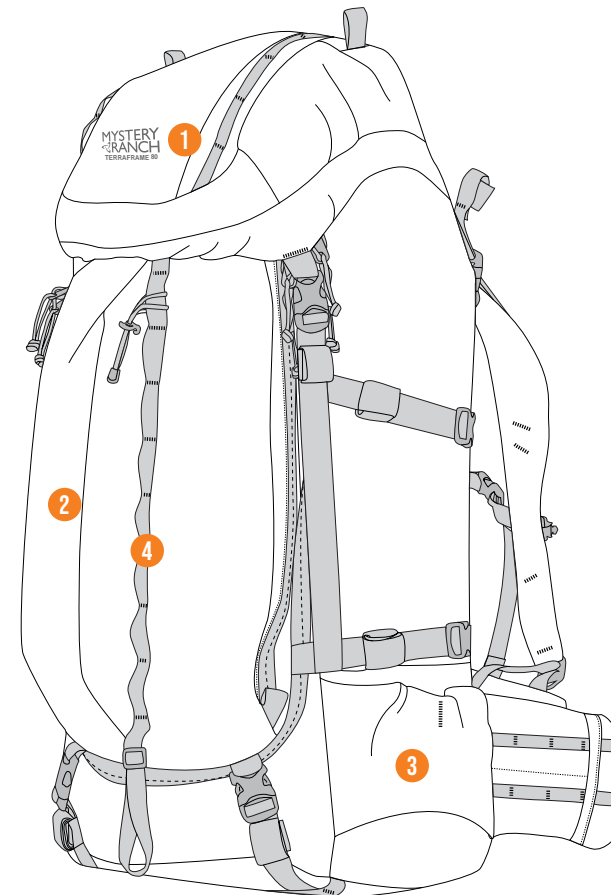

## SPECS:

Weight: 2.8 kg (6.1 lbs)

Vol: 80 L (4870 cu-in)

Size: Men's S M L XL



Loden



# TERRAFRAME 65

Like its 80 L big brother, this pack is a load hauler that allows you to bring as much or as little as you like – no sacrificing the creature comforts here.

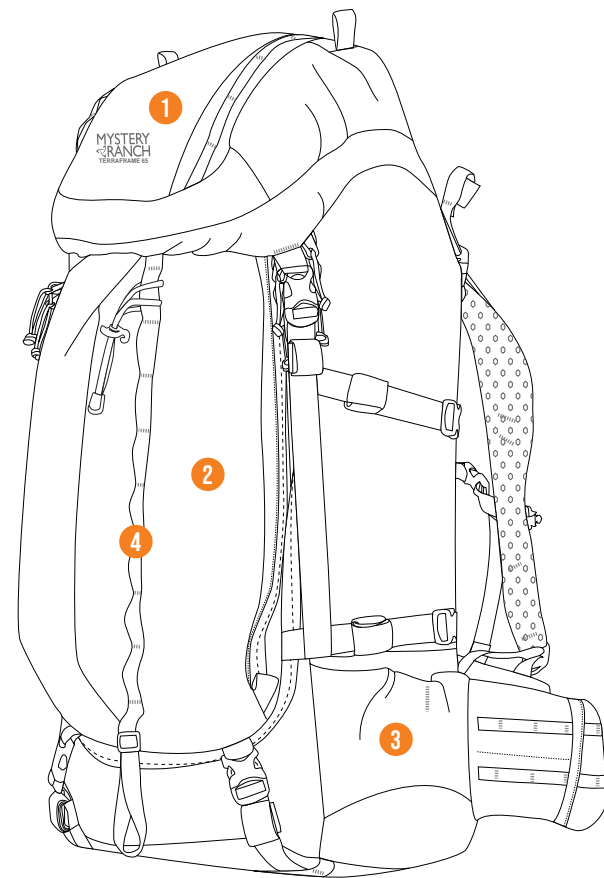

## KEY FEATURES:

- 1 Convertible Daypack Lid with porting for hydration
- 2 Two external long pockets for rapid access
- 3 Stretch-woven water bottle pockets and hydration reservoir-compatible
- 4 Daisy chain with adjustable tool attach loops
  - Quick-attach frame cap hardware provides easier OVERLOAD® feature
  - Top-loading shroud with full-bag zippered panel access around back pockets
  - Telescoping yoke for custom torso fit
  - Hydration reservoir compatible

 **GUIDE LIGHT MT™**  
FRAME

 **OVERLOAD®**  
FEATURE

## SPECS:

Weight: 2.6 kg (5.7 lbs)  
 Vol: 65 L (3966 cu-in)  
 Size: Men's S M L XL



Black

Deep Sea

# TERRAFRAME 3-ZIP 50

Blending two of our most crucial designs – the 3-ZIP and OVERLOAD® features – the TERRAFRAME 3-ZIP 50 is for mountain zealots who need the flexibility to go light or go big.

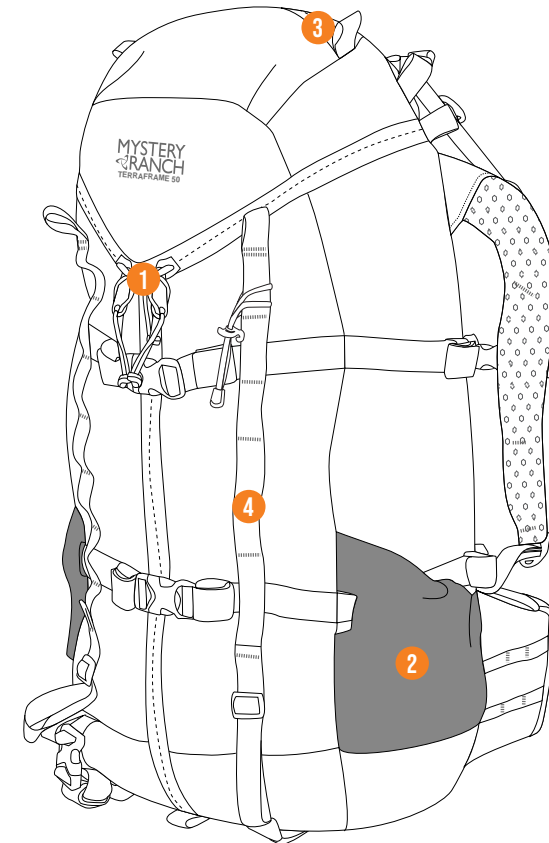

## KEY FEATURES:

- 1 3-ZIP design for rapid and complete access to gear
- 2 Stretch-woven water bottle pockets and hydration reservoir-compatible
- 3 Zippered lid pockets
- 4 Daisy chains with adjustable tool attach loops
  - Quick-attach frame cap hardware provides easier OVERLOAD® feature
  - Telescoping yoke for custom torso fit
  - Hydration reservoir compatible

 **GUIDE LIGHT MT™**  
FRAME

 **OVERLOAD®**  
FEATURE

## SPECS:

Weight: 2.3 kg (5 lbs)  
 Vol: 50 L (3051 cu-in)  
 Size: Men's S M L XL



Black

Loden



# FEATURE-RICH – TO HELP YOU PACK IN FURTHER.

## EXPEDITION PACK FEATURES

The EXPEDITION series is our most revered collection of packs. Built with advanced construction methods and materials, these packs are ideal for long weekend outings and extended backpacking trips, and they are capable of hauling 60+ pounds of survival essentials. The GLACIER, TERRAPLANE, AND T 100 showcase these purposeful features.

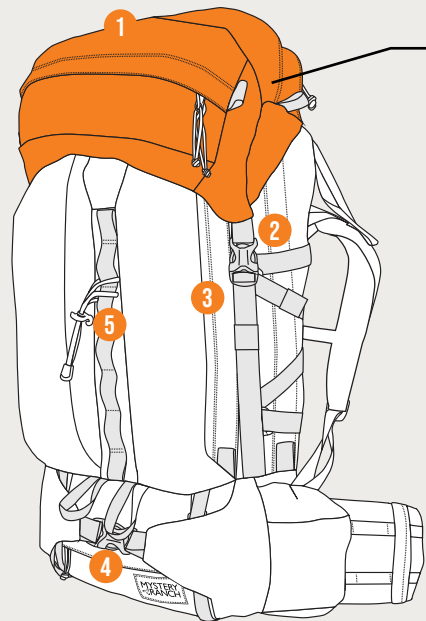

This revolutionary backpack design transforms your single pack into two packs - by transferring the main pack's yoke over to the removable lid, it quickly morphs into a fully functional summit pack that is hydration-compatible. This feature is available on the GLACIER, TERRAPLANE, T 100, and TERRAFRAME 65 & 80.

### KEY FEATURES:

- 1 Lid transforms into day pack when yoke is attached
- 2 Side zips for easy access to main bag without unpacking
- 3 Two front long torpedo pockets for rapid access
- 4 Speedzip™ compartment for easy access to sleeping bag
  - Water bottle pockets and hydration reservoir-compatible
  - Top-loading shroud for easy packing
  - Hydration reservoir compatible
- 5 Tool carry attachment between vertical torpedo pockets

### INTERNAL ASTRAL FRAME

Built with innovative construction methods and super durable materials, the ASTRAL Frame fully demonstrates our Load Carriage™ creed.

### KEY FEATURES:

- 1 Super durable webbing
- 2 Dense XPE foam for targeted flexibility at top and bottom
- 3 HDPE plastic for torsional rigidity
- 4 Four vertical, composite stays

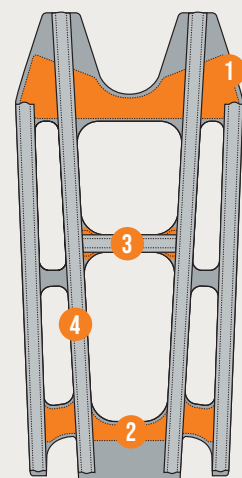

Internal Astral Frame



Black

## T 100

Weight: 3.4 kg (7.4 lbs)  
 Vol: 100 L (6102 cu-in)  
 Size: Men's  S  M  L  XL



Cherry

Del Mar

## TERRAPLANE

Weight: 3.1 kg (6.8 lbs)  
 Vol: 83 L (5059 cu-in)  
 Size: Men's  S  M  L  XL



Cherry

Del Mar

## GLACIER MEN'S

Weight: 2.9 kg (6.4 lbs)  
 Vol: 71 L (4320 cu-in)  
 Size: Men's  S  M  L  XL

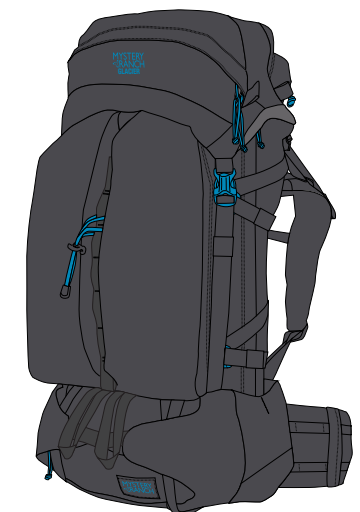

Shadow Moon

## GLACIER WOMEN'S

Weight: 2.9 kg (6.4 lbs)  
 Vol: 71 L (4320 cu-in)  
 Size:  XS  S  M  L



# HIKING PACKS

**MYSTERY RANCH day packs are the workhorses for your next adventure.**

These are our go-to-packs for various types of hikes — from half-day, head-clearing blitzes to fast and light week-long treks.





NEW

# RADIX 57

The RADIX 57 is the best lightweight pack that's not short on comfort or load bearing capabilities. The removable, lightweight aluminum frame, lid and waist belt allows you to choose how to carry those grams so you can have the endurance to crush hundreds of miles of trail.

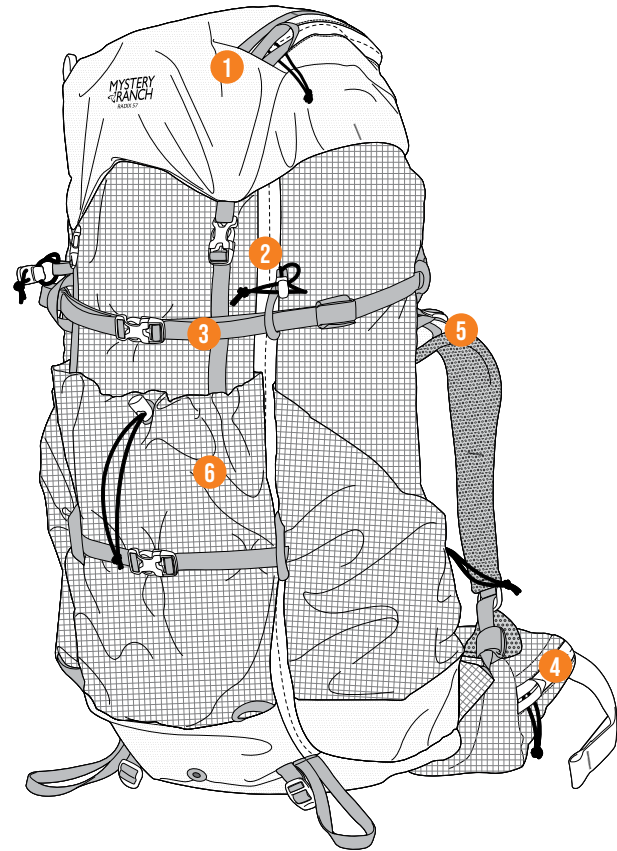

### KEY FEATURES:

- 1 Removable pocketed lid gives you the option of keeping your snacks, camera, and other essentials close at hand on the trail
  - 2 Off-center zipper for more convenient accessibility
  - 3 Removable and repairable compression web and repairable trim means that this pack won't be wearing out anytime soon
  - 4 Removable pocketed waistbelts keep your essentials close at hand on the trail
  - 5 Adjustable lightweight harnessing makes your hike that much more comfortable
  - 6 Easily compressible front and side pockets are perfect for holding light layers, water bottles, and/or things you need to get to or stash away quickly
- Removable 7000 Series, aerospace aluminum frame offers just the right load-bearing support for what your mountain mission requires
  - Technical Ultra-PE Birdseye and recycled 100D Robic Ripstop fabric means you can trust this pack to hold up all the way to the peak and back
  - Men's and women's harnessing options for a superior ergonomic fit with your body
  - Hydration reservoir compatible

### SPECS:

#### MEN'S

Weight: 1.72 kg (3.78 lbs)  
 Stripped Weight: 1.37 kg (3.02 lbs)  
 Vol: 59.6 L (3635 cu-in)  
 Size: S M L XL

#### WOMEN'S

Weight: 1.72 kg (3.78 lbs)  
 Stripped Weight: 1.37 kg (3.02 lbs)  
 Vol: 59.6 L (3635 cu-in)  
 Size: XS S M L



Black/Hunter Men's    White/Hunter Men's    Black/Sunset Women's    White/Sunset Women's

NEW

# RADIX 47

The lightweight design of the RADIX 47 was made to be highly adaptable, fast, and durable. Top-loading shroud, ample exterior pockets, and removable aluminum frame gives you the option of how you want to carry your essentials – really light or right light.

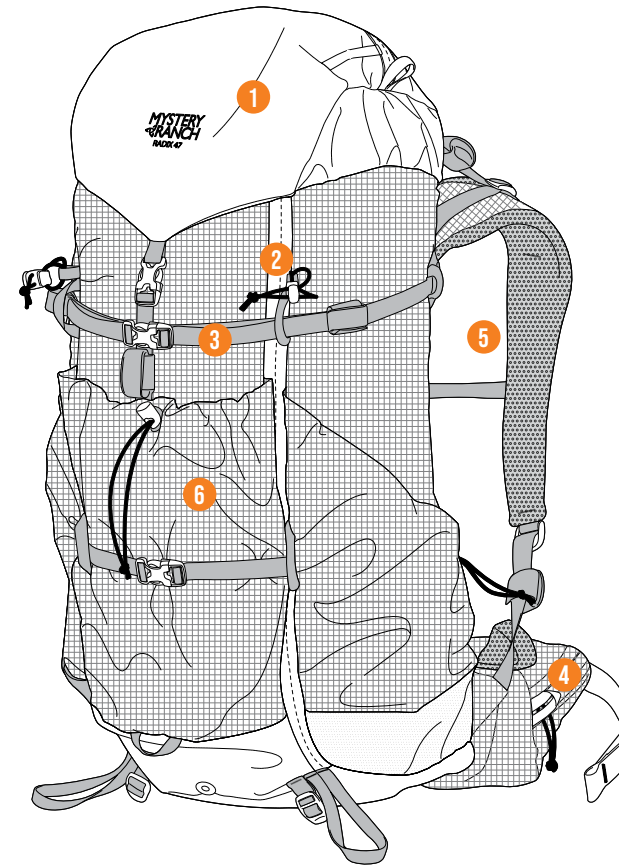

### KEY FEATURES:

- 1 Pocketed lid keeps your essentials close at hand
  - 2 Off-center zipper for more convenient accessibility
  - 3 Removable and repairable compression web and repairable trim means that this pack won't be wearing out anytime soon
  - 4 Removable pocketed waist belt keeps you snacks, phone, or sunglasses easily accessible
  - 5 Adjustable lightweight harnessing makes your hike that much more comfortable
  - 6 Easily compressible front and side pockets are perfect for holding light layers, water bottle, and/or things you need to get to or stash away quickly
- Removable 7000 Series, aerospace aluminum frame offers just the right load-bearing support for what your mountain mission requires
  - Technical Ultra-PE Birdseye and recycled 100D Robic Ripstop fabric means you can trust this pack to hold up all the way to the peak and back
  - Men's and women's harnessing options for a superior ergonomic fit with your body
  - Hydration reservoir compatible

### SPECS:

#### MEN'S

Weight: 1.56 kg (3.43 lbs)  
 Stripped Weight: 1.40 kg (3.10 lbs)  
 Vol: 45 L (2745 cu-in)  
 Size: S M L XL

#### WOMEN'S

Weight: 1.56 kg (3.43 lbs)  
 Stripped Weight: 1.40 kg (3.10 lbs)  
 Vol: 45 L (2745 cu-in)  
 Size: XS S M L



Black/Hunter Men's    White/Hunter Men's    Black/Sunset Women's    White/Sunset Women's



NEW

# RADIX 31

We designed the RADIX 31 with three things in mind: speed, versatility, and durability. With its lightweight design, it's a delight for the ardent peak bagger and ambitious day hiker alike.

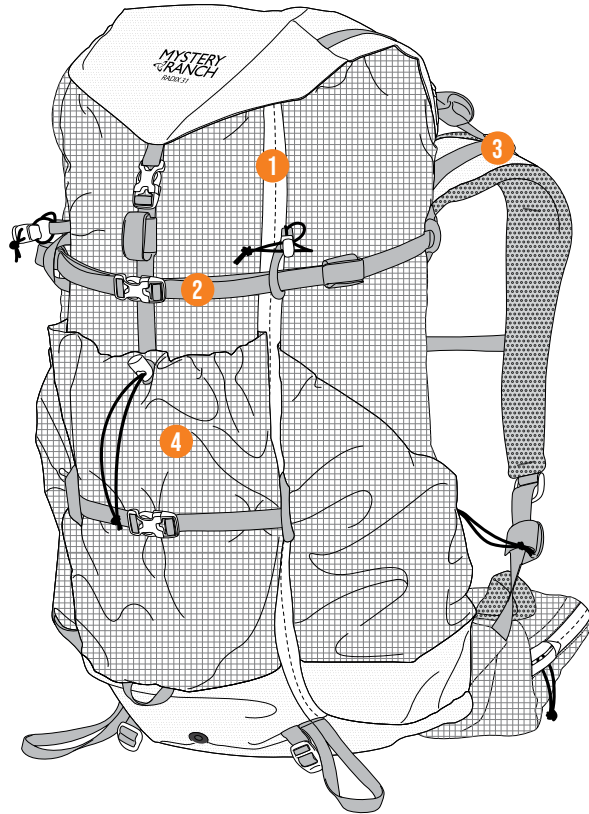

### KEY FEATURES:

- 1 Off-center zipper for more convenient accessibility
  - 2 Removable and repairable compression web and repairable trim means that this pack won't be wearing out anytime soon
  - 3 Adjustable lightweight harnessing makes your hike that much more comfortable
  - 4 Easily compressible front and side pockets are perfect for holding light layers, water bottle, and/or thing you need to get to or stash away quickly
- Technical Ultra-PE Birdseye and recycled 100D Robic Ripstop fabric means you can trust this pack to hold up all the way to the peak and back
  - Removable 7000 Series, aerospace aluminum frame offers just the right load-bearing support for what your mountain mission requires
  - Men's and women's harnessing options for a superior ergonomic fit with your body
  - Hydration reservoir compatible

### SPECS:

<b>MEN'S</b>	
Weight:	1.39 kg (3.06 lbs)
Stripped Weight:	1.24 kg (2.73 lbs)
Vol:	28.8 L (1755 cu-in)
Size:	<input type="checkbox"/> S <input type="checkbox"/> M <input type="checkbox"/> L <input type="checkbox"/> XL
<b>WOMEN'S</b>	
Weight:	1.39 kg (3.06 lbs)
Stripped Weight:	1.24 kg (2.73 lbs)
Vol:	28.8 L (1755 cu-in)
Size:	<input type="checkbox"/> XS <input type="checkbox"/> S <input type="checkbox"/> M <input type="checkbox"/> L



Black/Hunter Men's    White/Hunter Men's    Black/Sunset Women's    White/Sunset Women's





NEW

# SCREE 33

The SCREE 33 is the technical 33-liter pack that works with all kinds of off trail pursuits. With tons of adjustable compression, daisy chain with tool attachment points, adjustable yoke, and removable waist belt – this will be your favorite companion from peak to rock to snow.

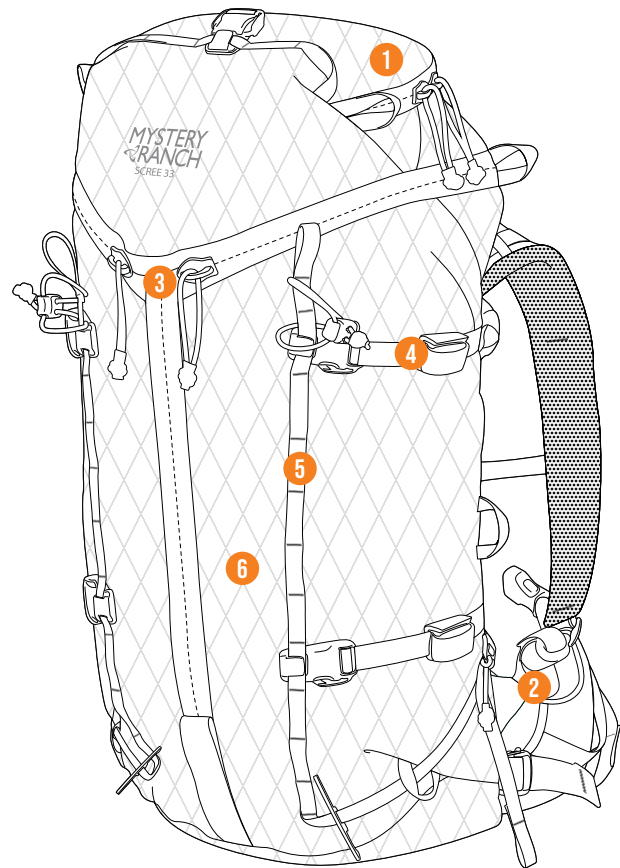

### KEY FEATURES:

- 1 Zippered lid pocket to keep small items accessible
  - 2 Adjustable yoke and removable belt give you options for finding the most comfortable way to traverse the wild
  - 3 3-ZIP access cuts down on unnecessary fumbling when you need to get the guts of your pack
  - 4 Adjustable compression keeps the guts of your pack snug and secure
  - 5 Daisy chain and tool attachment feature for staying prepared to navigate difficult terrain
  - 6 Technical custom laminate fabric provides enough durability to withstand the rough and tumble of trail life for many seasons to come
- Removable 7000 Series, aerospace aluminum frame offers just the right load-bearing support for what your mountain mission requires
  - Thinner, lighter, and faster to streamline your outdoor adventure experience
  - Hydration reservoir compatible

### SPECS:

#### MEN'S

Weight: 1.49 kg (3.27 lbs)  
 Vol: 32.8 L (2000 cu-in)  
 Size: S M L XL

#### WOMEN'S

Weight: 1.49 kg (3.27 lbs)  
 Vol: 32.8 L (2000 cu-in)  
 Size: XS S M L



Black Men's    Limeade Men's    White/Limeade Men's    Gravel Women's    White/Sunset Women's

NEW

# SCREE 22

Your next wilderness destination awaits, and so does the technical pack that will get you there. The SCREE 22 is a streamlined durable pack built for hauling nothing but your essential gear to bring you to the top of the mountain and back again.

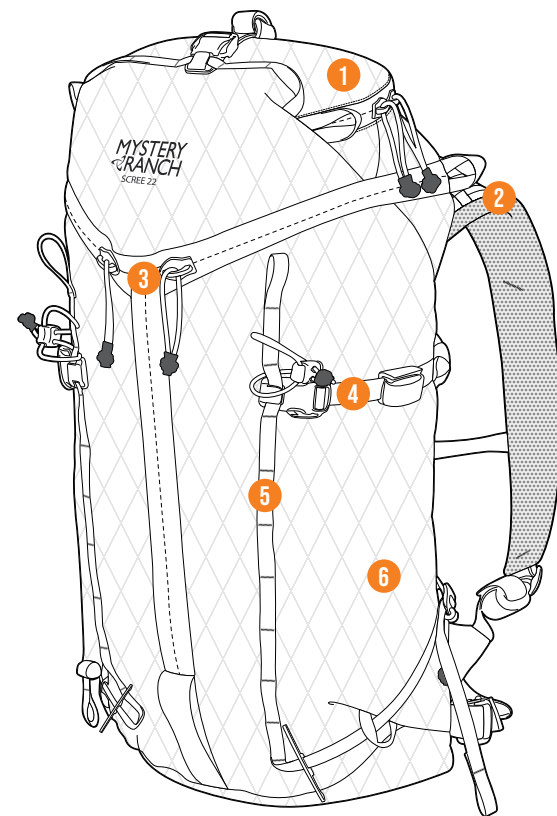

### KEY FEATURES:

- 1 Zippered lid pocket to keep small items accessible
  - 2 Fixed harnessing ensures a consistent fit and sturdy load-hauling during grueling adventures
  - 3 3-ZIP access cuts down on unnecessary fumbling when you need to get the guts of your pack
  - 4 Adjustable compression keeps the guts of your pack snug and secure
  - 5 Daisy chain and tool attachment feature for staying prepared to navigate difficult terrain
  - 6 Technical custom laminate fabric provides enough durability to withstand the rough and tumble of trail life for many seasons to come
- Thinner, lighter, and faster to streamline your outdoor adventure experience
  - Hydration reservoir compatible

### SPECS:

Weight: 0.88 kg (1.94 lbs)  
 Vol: 22 L (1335 cu-in)  
 Size: One Size



Black    Limeade    White/Limeade



NEW

# GALLAGATOR 25

The lightweight GALLAGATOR 25 pack is the jack-of-all-trades. It's just the right size for all adventures – from rugged mountain trails to intercity strolls.



**KEY FEATURES:**

- 1 3-ZIP access cuts down on unnecessary fumbling when you need to get to the guts of your pack
- 2 Pocketed shoulder pads offer more organization and storage for the small things like a phone or sunglasses
- 3 Lid pocket with integrated key clip provides rapid access to your keys, snacks, a first aid kit, and other hiking essentials
- 4 Compression and daisy chain with a shock cord tool attachment keep everything you're hauling snug and give you a place to clip extra gear
- 5 Side Jelspan pockets on exterior for quick access to water bottle and stashing extra layers
  - Hydration reservoir compatible
  - Lightweight fabric made from partially recycled materials makes this pack a breeze to carry

**SPECS:**

Weight: 0.65 kg (1.43 lbs)  
 Vol: 24 L (1464 cu-in)  
 Size:  S/M  L/XL



Black Fox Hummus Dobby



Pacific Twig

NEW

# GALLAGATOR 20

From town to trail, sometimes you need a little extra room for the day's escapades. The GALLAGATOR 20 has just the right amount of space to hit the hiking trail to your favorite destination or carry as a trusted travel pack.



**KEY FEATURES:**

- 1 3-ZIP access cuts down on unnecessary fumbling when you need to get to the guts of your pack
- 2 Pocketed shoulder pads offer more organization and storage for the small things like a phone or sunglasses
- 3 Lid pocket with integrated key clip provides rapid access to your keys, snacks, a first aid kit, and other hiking essentials
- 4 Compression and daisy chain with shock cord tool attachment keep everything you're hauling snug and gives you a place to clip extra gear
  - Hydration reservoir compatible
  - Lightweight fabric made from partially recycled materials makes this pack a breeze to carry

**SPECS:**

Weight: 0.54 kg (1.18 lbs)  
 Vol: 17 L (1035 cu-in)  
 Size:  S/M  L/XL



Black Gravel Hummus Dobby



Pacific Paprika



NEW

# GALLAGATOR 15

The GALLAGATOR 15 is designed to meet the needs of the trail runner, casual hiker, or minimalist dirt scrambler who wants to elevate the experience of their outdoor adventures and leisurely day-to-day exploits. This pack has enough room to stow a bottle of water, hearty snacks, an extra layer, headlamps, or a first aid kit.



**KEY FEATURES:**

- 1 Simple rip-zip access cuts down on unnecessary fumbling when you need to get to the guts of your pack
  - 2 Pocketed shoulder pads offer more organization and storage for the small things like a phone or sunglasses
  - 3 Lid pocket with integrated key clip provides rapid access to your keys, snacks, a first aid kit, and other hiking essentials
  - 4 Compression and bungee panel keep everything you're hauling snug and give you yet another accessible storage option
- Hydration reservoir compatible
  - Lightweight fabric made from partially recycled materials makes this pack a breeze to carry

**SPECS:**

Weight: 0.59 kg (1.3 lbs)  
 Vol: 14 L (855 cu-in)  
 Size: S/M L/XL



NEW

# GALLAGATOR 10

The GALLAGATOR 10 is built just right to hit the trail for a run, a short day hike or cruise the streets as a trusty commuting or travel pack. At 10-liters, it has just enough room for the essentials – which is all you need.

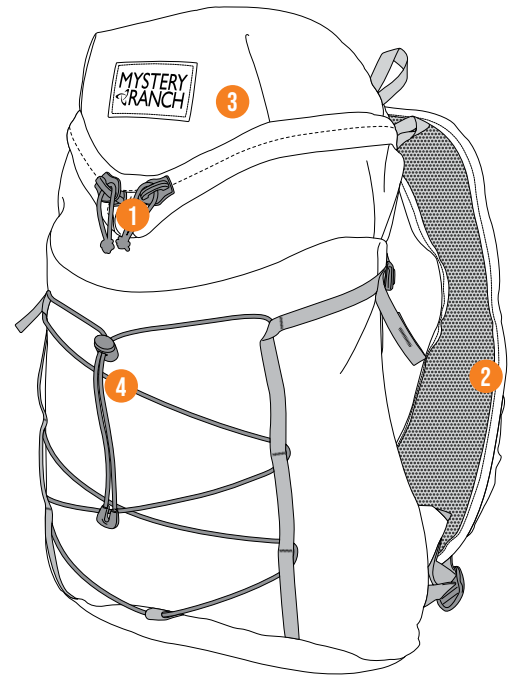

**KEY FEATURES:**

- 1 Simple rip-zip access cuts down on unnecessary fumbling when you need to get to the guts of your pack
  - 2 Pocketed shoulder pads offer more organization and storage for the small things like a phone or sunglasses
  - 3 Lid pocket with integrated key clip provides rapid access to your keys, snacks, a first aid kit, and other hiking essentials
  - 4 Compression and bungee panel keep everything you're hauling snug and give you yet another accessible storage option
- Hydration reservoir compatible
  - Lightweight fabric made from partially recycled materials makes this pack a breeze to carry

**SPECS:**

Weight: 0.41 kg (0.91 lbs)  
 Vol: 9 L (550 cu-in)  
 Size: S/M L/XL





# ENDURANCE YOKE

## TRAIL RUNNING TECH MEETS BACKPACKING

That's how the MYSTERY RANCH Endurance Yoke was born. This innovative, running-vest-inspired design offers backpackers the same quick, convenient accessibility built for trail runners. The stretch-mesh pockets on the shoulders and waist fit your water, snacks, bear spray, or anything you immediately need – without having to stop and dig through your pack. It's also designed for maximum breathability and airflow – keeping you cool and comfortable – and built for endurance on the trail.

## FEATURES THAT KEEP YOU COOL AS A CUCUMBER

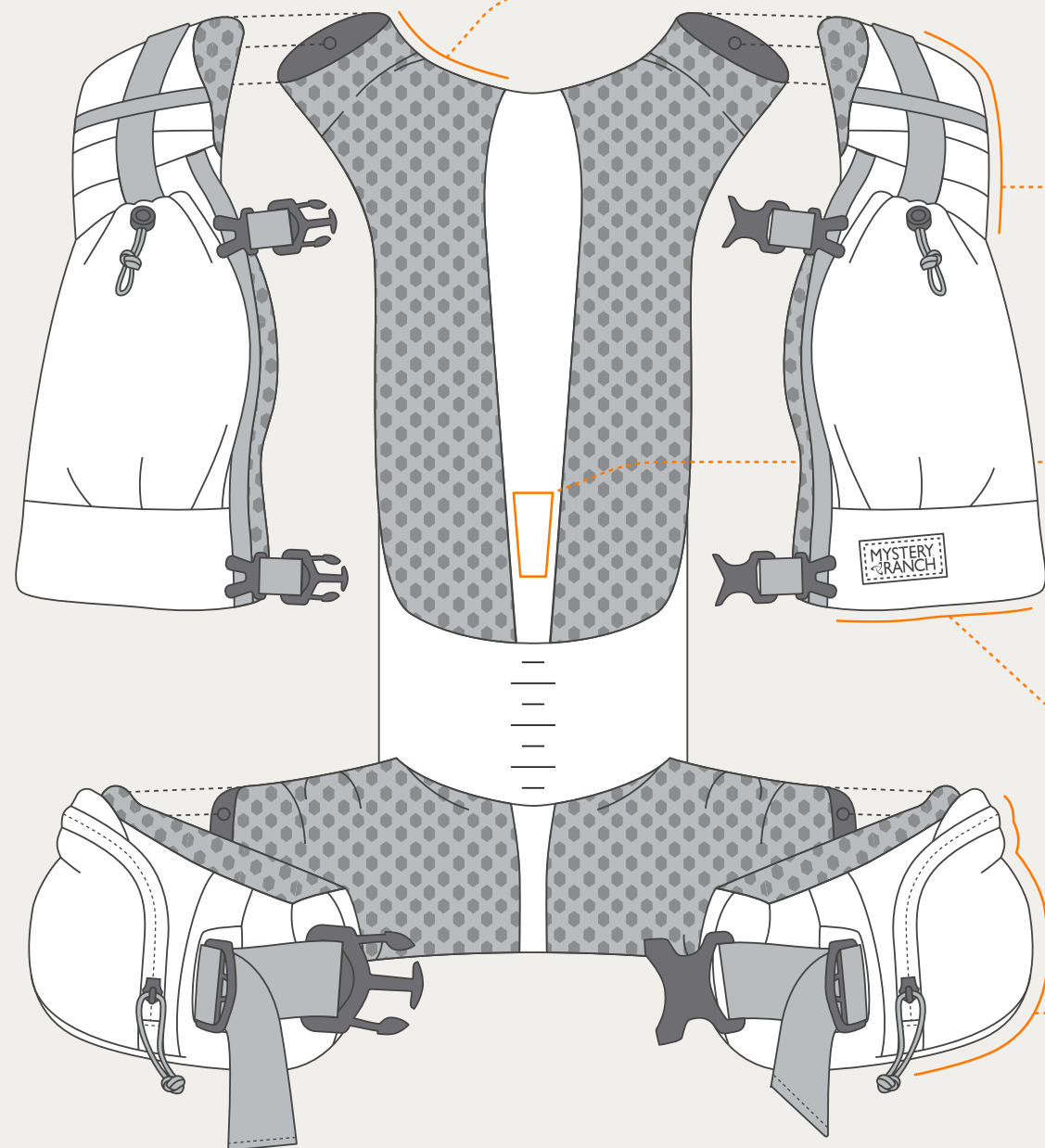

①

### GAME-CHANGING FABRIC

Specialized foam, cool air mesh, and moisture-wicking fabric allow air to flow while minimizing friction and heat to keep you cool.

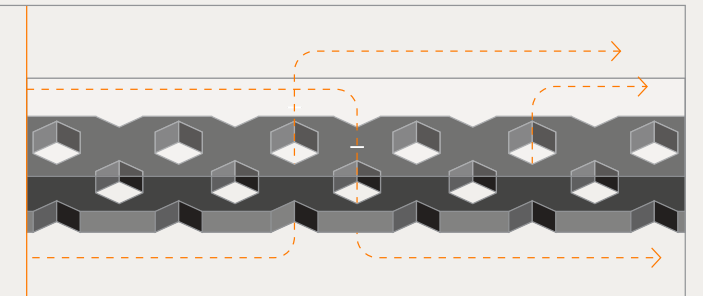

②

### BREATHABLE SHOULDER PADS

Thoughtful design and aerated fabrics promote optimal comfort and breathability.

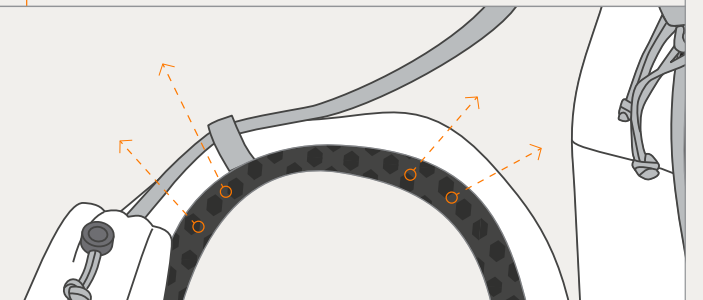

③

### DIRECTED AIR FLOW

The innovative frame and yoke integration minimize back-to-pack contact, maximizing airflow by creating air channels in the yoke.

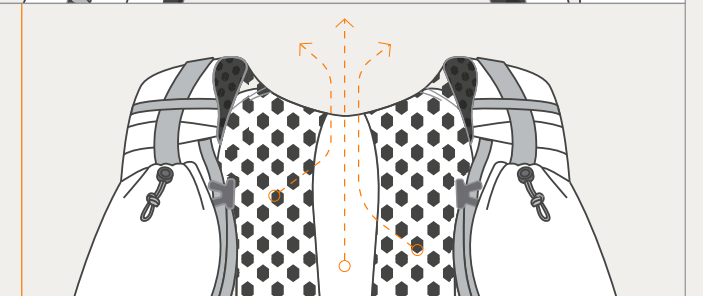

④

### RUNNING-INSPIRED VEST

Two stretch shoulder pockets provide convenient, quick access to your water or snacks so you can keep trekking.

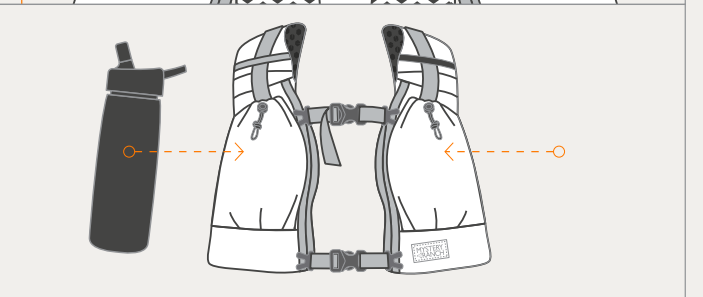

⑤

### MORE POCKETS WHERE YOU NEED THEM

Two zippered stretch pockets on the waist belt to quickly grab or stash your phone or sunglasses.

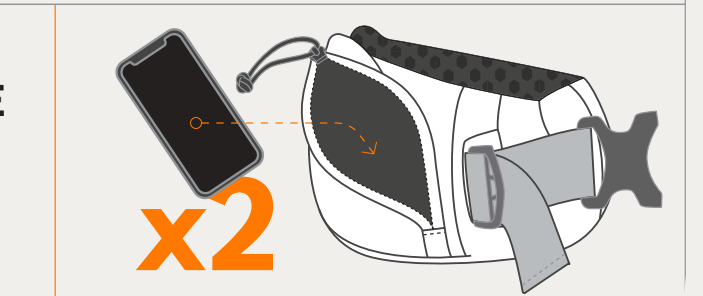



# BRIDGER 65

The BRIDGER 65 is the Cadillac of backpacks. It's a feature-rich, weight-conscious, and durable pack that supports your overnight or multi-day backpacking adventure.

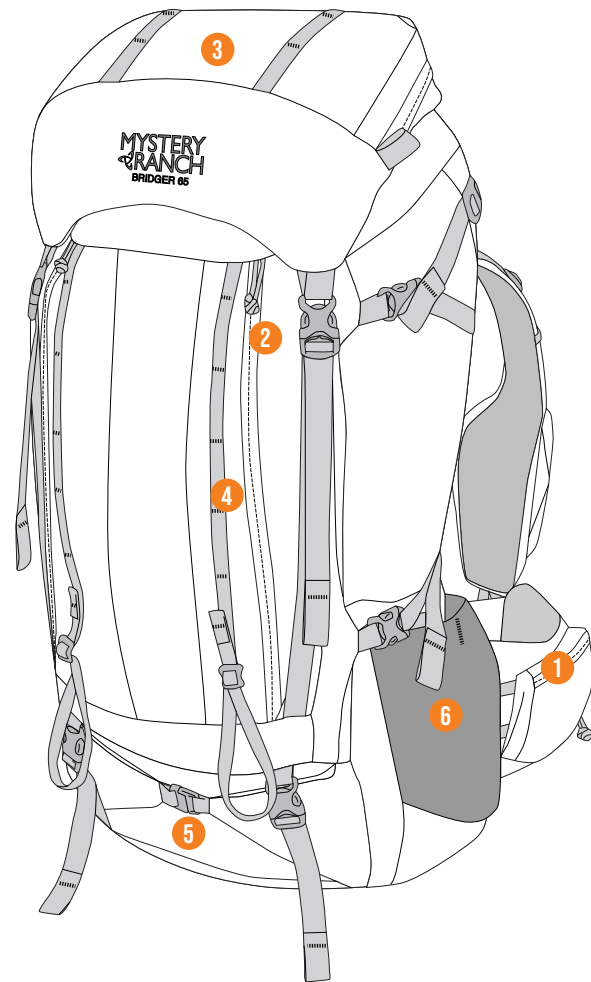

## KEY FEATURES:

- 1 Breathable Endurance Yoke and slim wrap waistbelt with ample pockets for quick access to water bottle or snacks
- 2 Dual access to main bag: Drawstring shroud access or two full-length zipper access
- 3 Removable lid that converts to a hip pack for quick and close adventures
- 4 Double daisy chain and tool attachment
- 5 Speed Zip™ sleeping bag compartment with removable divider
- 6 Two large stretch-woven back pockets with inner and elastic-topped dump pockets
  - Internal spring steel wire frame

## SPECS:

### MEN'S

Weight: 2.5 kg (5.5 lbs)  
 Vol: 63 L (3844.5 cu-in)  
 Size: S M L XL

### WOMEN'S

Weight: 2.5 kg (5.5 lbs)  
 Vol: 63 L (3844.5 cu-in)  
 Size: XS S M L



Copper Men's

Wood Men's

Shadow Moon Women's

Techno Women's

# BRIDGER 55

This pack has all of the organizational features for easy packing and quick access to stash pockets on the back and harness of the bag. It's comfortable to carry and very breathable, because when you trust your gear, you can focus on the outdoors.

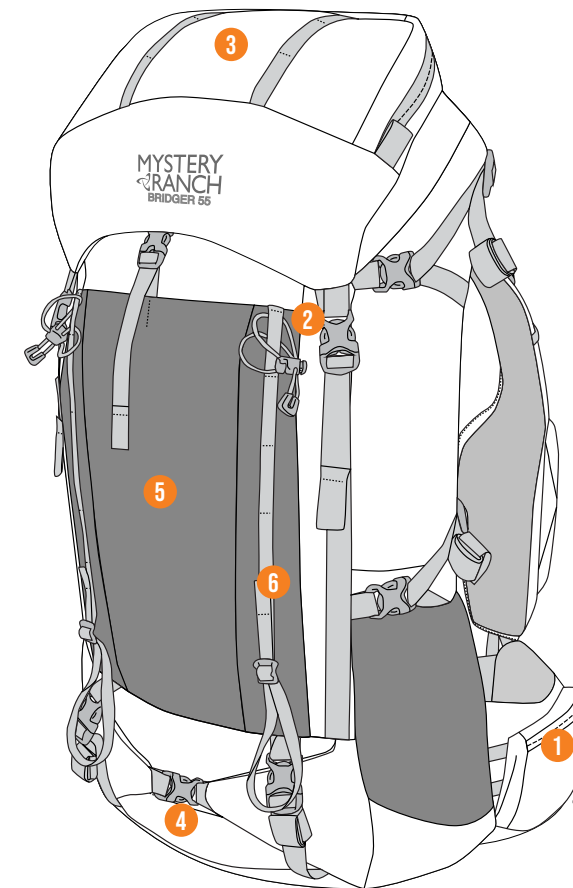

## KEY FEATURES:

- 1 Breathable Endurance Yoke and slim wrap waistbelt with ample pockets for quick access to water bottle or snacks
- 2 Dual access to main bag: Drawstring shroud access or two full-length zipper access
- 3 Removable lid that converts to a hip pack for quick and close adventures
- 4 Speed Zip™ sleeping bag compartment with removable divider
- 5 Large stretch-woven back pocket
- 6 Double daisy chain and tool attachment
  - Internal spring steel wire frame

## SPECS:

### MEN'S

Weight: 2.4 kg (5.2 lbs)  
 Vol: 54.7 L (3337.9 cu-in)  
 Size: S M L XL

### WOMEN'S

Weight: 2.4 kg (5.2 lbs)  
 Vol: 54.7 L (3337.9 cu-in)  
 Size: XS S M L



Del Mar Men's

Hummus Men's

Shadow Moon Women's

Spring Women's



# BRIDGER 45

Whether you're packing for a sunrise-to-sunset day hike or making a weekend getaway into the wilderness, the BRIDGER 45 was built to exceed your mission needs.



## KEY FEATURES:

- 1 Breathable Endurance Yoke and slim Endurance Wrap belt with ample pockets for quick access to water bottle or snacks
- 2 Removable lid that converts to a crossbody, sling-style bag for quick and close adventures
- 3 Full-bag length, double zippered access for easy and fast opening to main bag
- 4 Double daisy chain and tool attachment
- 5 Speed Zip™ sleeping bag compartment with removable divider
  - Attach loops on the body panel for MYSTERY RANCH QUICK ATTACH ZOID BAGS or other accessory carry
  - Two small dump pockets, one on each interior side of the bag for extra storage
  - Spring steel wire frame

## SPECS:

### MEN'S

Weight: 2 kg (4.4 lbs)  
 Vol: 45 L (2746 cu-in)  
 Size: S M L XL

### WOMEN'S

Weight: 2 kg (4.4 lbs)  
 Vol: 45 L (2746 cu-in)  
 Size: XS S M L



Mineral Gray Men's

Black Men's

Aura Women's

Pebble Women's

# BRIDGER 35

Built for grueling in-and-outs or minimalist overnights, the BRIDGER 35 marries comfort and functionality to answer every challenge your weekend throws your way.

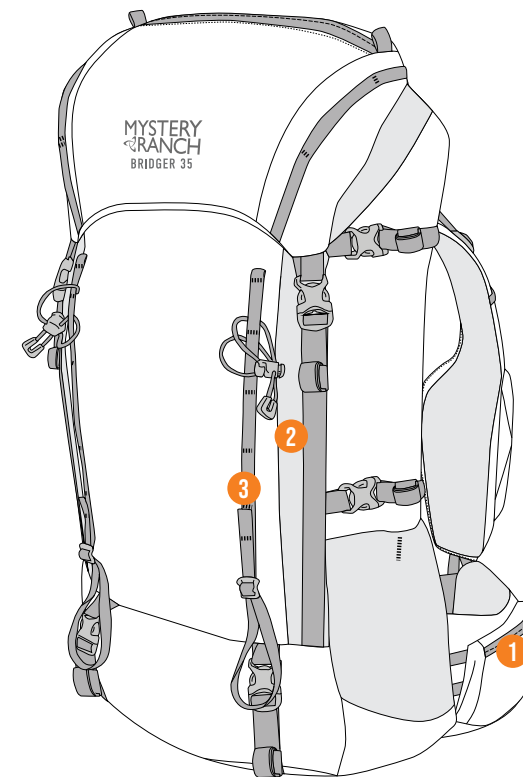

## KEY FEATURES:

- 1 Breathable Endurance Yoke and slim Endurance Wrap belt with ample pockets for quick access to water bottle or snacks
- 2 Double zippered access for easy and fast opening to main bag
- 3 Double daisy chain and tool attachment
  - Attach loops on the body panel for MYSTERY RANCH QUICK ATTACH ZOID BAGS or other accessory carry
  - Spring steel wire frame
  - Two small dump pockets, one on each interior side of the bag for extra storage

## SPECS:

### MEN'S

Weight: 1.7 kg (3.7 lbs)  
 Vol: 35 L (2136 cu-in)  
 Size: S M L XL

### WOMEN'S

Weight: 1.7 kg (3.7 lbs)  
 Vol: 35 L (2136 cu-in)  
 Size: XS S M L



Black Men's

Mineral Gray Men's

Fox Men's

Aura Women's

Twig Women's



MIPAN  
**regen robic**

The most environmentally friendly products are those that endure — which is why since our founding in 2000, MYSTERY RANCH has been committed to protecting the environment. Minimizing poly bagging and incorporating recycled and recyclable materials in our packaging program was a start, and in 2022 we took it one step further by incorporating recycled fabrics into our packs. The COULEE SERIES incorporates 100% recycled nylon: MIPAN Regen Robic.

MIPAN Regen Robic is the first recycled high-tenacity nylon made from 100% reclaimed waste (pre-consumer), developed for eco-conscious enthusiasts who rely on their gear wherever the adventure takes them.

Recycled. Robust. Resilient.





# COULEE 50

For those who take on life with a “go big or go home” mindset, the new-generation COULEE 50 is ready to help you gear up for your next mountain mission.

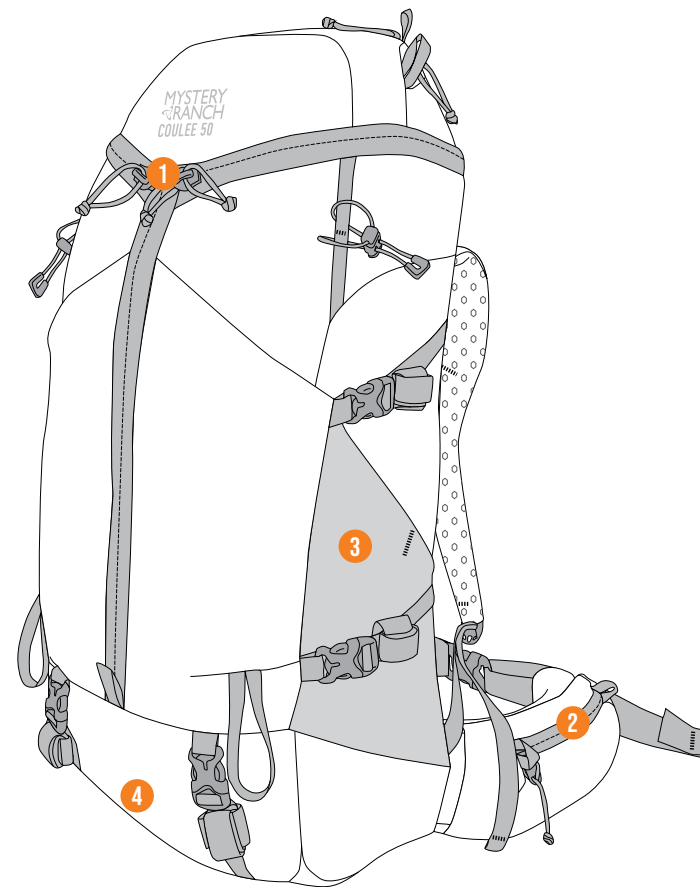

## KEY FEATURES:

- 1 3-ZIP access allows for easy, rapid access to the interior
  - 2 Removable pocketed waist belt
  - 3 Side stretch-woven pockets on the exterior for easy water bottle access
  - 4 Sleeping bag compartment with U-Shaped opening for easy stow and accessibility
- Lightweight Trail yoke that micro-adjusts to the torso length
  - Attach loops inside on the body panel for the MYSTERY RANCH QUICK ATTACH ZOID BAGS or other accessory carry
  - Cushioned lumbar support for optimal comfort
  - Made with partially recycled materials

## SPECS:

### MEN'S

Weight: 1.8 kg (4 lbs)  
 Vol: 50 L (3051 cu-in)  
 Size:  S  M  L  XL

### WOMEN'S

Weight: 1.8 kg (4 lbs)  
 Vol: 50 L (3051 cu-in)  
 Size:  XS  S  M  L



Black Men's

Noble Fir Men's

Paprika Women's

Pebble Women's

# COULEE 40

For those motivated most by authentic encounters with nature, the COULEE 40 offers just the right amount of space for bold day hikes and minimalist overnights.

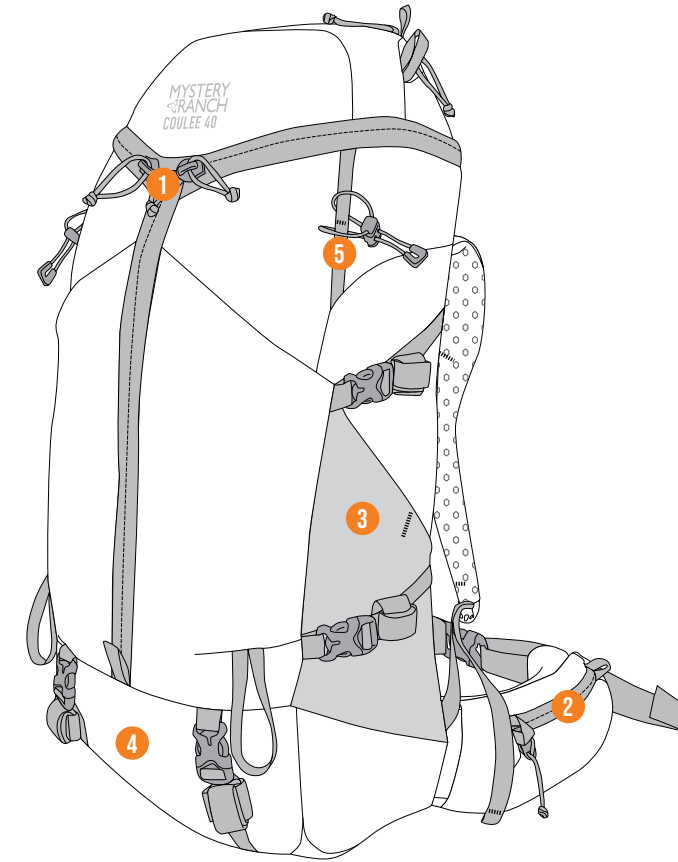

## KEY FEATURES:

- 1 3-ZIP access allows for easy, rapid access to the interior
  - 2 Removable pocketed waistbelt
  - 3 Side stretch-woven pockets on the exterior for easy water bottle access
  - 4 Sleeping bag compartment with U-Shaped opening for easy stow and accessibility
- Attach loops inside on the body panel for the MYSTERY RANCH QUICK ATTACH ZOID BAGS or other accessory carry
  - Cushioned lumbar support for optimal comfort
  - Lightweight Trail yoke that micro-adjusts to the torso length
  - Made with partially recycled materials

## SPECS:

### MEN'S

Weight: 1.7 kg (3.8 lbs)  
 Vol: 40 L (2441 cu-in)  
 Size:  S  M  L  XL

### WOMEN'S

Weight: 1.7 kg (3.8 lbs)  
 Vol: 40 L (2441 cu-in)  
 Size:  XS  S  M  L



Mineral Gray Men's

Stone Men's

Atlantic Women's

Aura Women's

# COULEE 30

The COULEE 30 offers enough heft and versatility to tackle day trips of all kinds, whether it's a hike up a local peak or an outing to your favorite park.

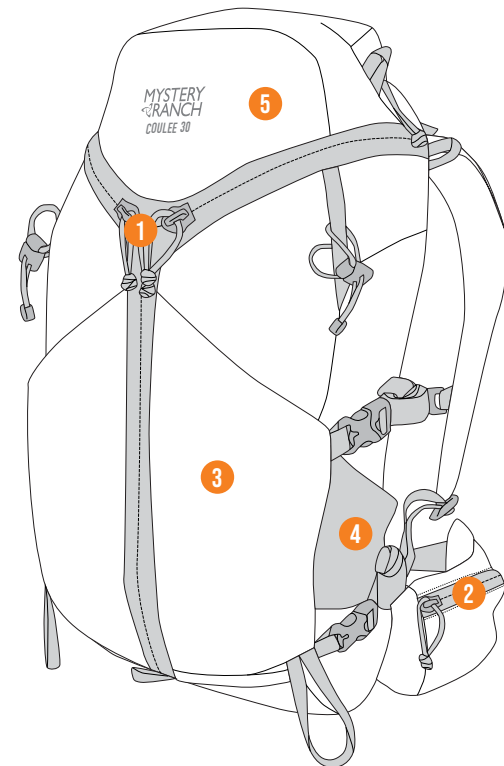

## KEY FEATURES:

- 1 3-ZIP access allows for easy, rapid access to the interior
  - 2 Pocketed waist belt offering extra storage and easy access to small items
  - 3 Back pockets with stretch-woven sides can accommodate light layers
  - 4 Side stretch-woven pockets on the exterior for easy water bottle access
  - 5 Top zippered lid compartment for storing small essentials, phone, or camera
- Attach loops inside on the body panel for the MYSTERY RANCH SMALL QUICK ATTACH ZOID BAG or other accessory carry
  - Lightweight Trail yoke that micro-adjusts to the torso length
  - Made with partially recycled materials

## SPECS:

### MEN'S

Weight: 1.2 kg (2.7 lbs)  
 Vol: 30 L (1770 cu-in)  
 Size:  S/M  L/XL

### WOMEN'S

Weight: 1.2 kg (2.7 lbs)  
 Vol: 30 L (1770 cu-in)  
 Size:  XS/S  M/L



# COULEE 20

A pack for light and fast adventures, the COULEE 20 is equally adept at blitzing up a peak or exploring your favorite trail or swimming hole.

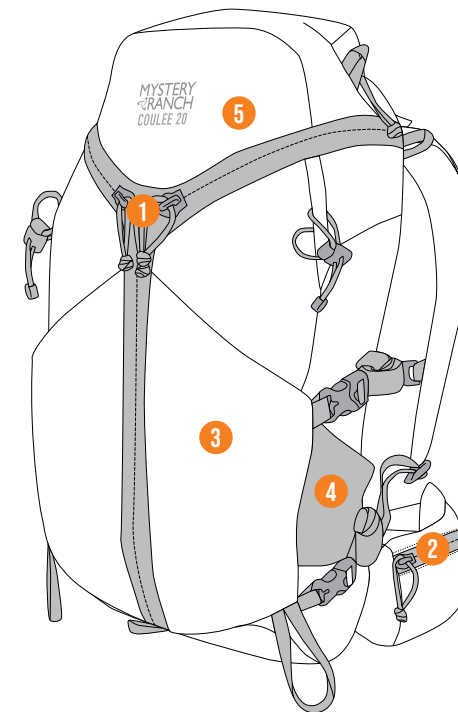

## KEY FEATURES:

- 1 3-ZIP access allows for easy, rapid access to the interior
  - 2 Pocketed waist belt offering extra storage and easy access to small items
  - 3 Back pockets with stretch-woven sides can accommodate light layers
  - 4 Side stretch-woven pockets on the exterior for easy water bottle access
  - 5 Top zippered lid compartment for storing small essentials, phone, or camera
- Attach loops inside on the body panel for the MYSTERY RANCH SMALL QUICK ATTACH ZOID BAG or other accessory carry
  - Lightweight Trail yoke that micro-adjusts to the torso length
  - Made with partially recycled materials

## SPECS:

### MEN'S

Weight: 1.2 kg (2.6 lbs)  
 Vol: 20 L (1221 cu-in)  
 Size:  S/M  L/XL

### WOMEN'S

Weight: 1.2 kg (2.6 lbs)  
 Vol: 20 L (1221 cu-in)  
 Size:  XS/S  M/L





# IN & OUT 19

Fast, light, and a perfect featherweight pack for carrying the essentials. This 19-liter wonder packs into its front pocket, making it an excellent hiking or travel companion.

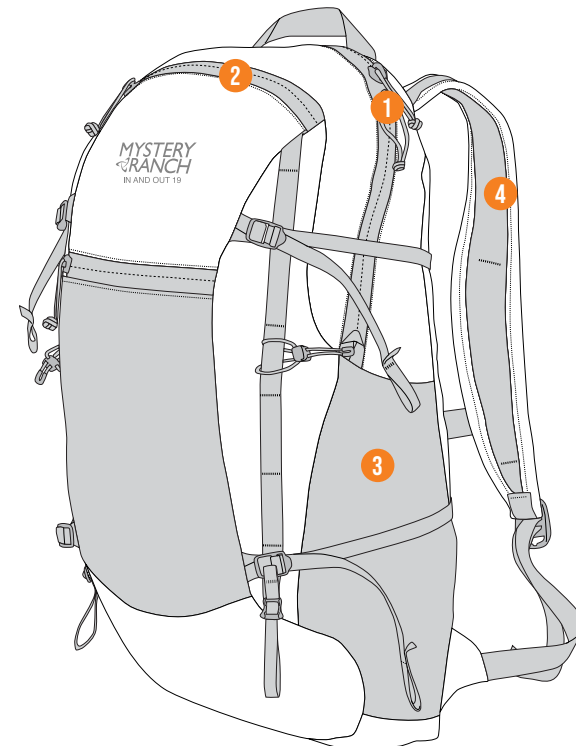

## KEY FEATURES:

- 1 Large, zippered access to main bag
- 2 Two, external zippered access pockets
- 3 Stretchy side pocket for water bottle or other small essentials
- 4 Think breathable shoulder pads with adjustable sternum strap
  - Thin breathable shoulder pads with adjustable sternum strap
  - Hydration reservoir-compatible

## SPECS:

Weight: 0.6 kg (1.3 lb)  
 Vol: 19 L (1160 cu-in)  
 Size: One Size



Stuffs into its own front pocket  
 (10"x6.5"x3")



Black Paprika Mineral Gray Hummus



Hunter Aura Pacific

# IN & OUT 22

Not your everyday stuff pack! This top-loading shroud pack allows easy, ample access to the main bag. The contoured shoulder straps and a sternum strap make for a light, comfortable, and super packable choice.

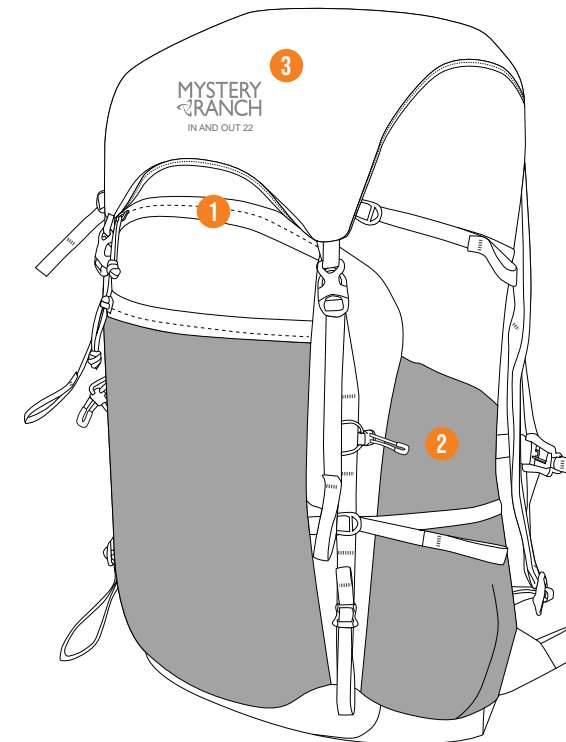

## KEY FEATURES:

- 1 Two, external zippered access pockets
- 2 Stretchy side pocket for water bottle or other small essentials
- 3 Lid flap for extra protection
  - Thin breathable shoulder pads with adjustable sternum strap
  - Hydration reservoir-compatible
  - Top-loading shroud with drawstring access

## SPECS:

Weight: 0.4 kg (0.9 lb)  
 Vol: 21.9 L (1336 cu-in)  
 Size: One Size



Stuffs into its own front pocket  
 (10"x6.5"x3")



Black Hummus Aura



Mineral Gray Paprika



# CLIMBING PACKS

**Specifically designed for the  
wants and needs of climbers.**

Carry your rope, crampons, and axes, or haul your draws, cord, and rock shoes — our climbing packs will keep your kit organized.





# SCEPTER 35 & 50

For those pursuing ice and rock, the SCEPTERS are designed to adapt to the requirements of the user while maintaining functionality with gloved hands.



## KEY FEATURES:

- 1 Lid is shaped to secure a rope or helmet with adjustable volume attach points
- 2 Glove-friendly buckles
- 3 Side Squeeze buckles provide access to the expandable pocket and separate access to the main bag through an additional drawstring shroud
- 4 Alpine yoke and belt easily adjusted or removed
  - Compression molded back panel and stretch-woven yoke repels snow

## SPECS:

### SCEPTER 35

Weight: 1.5 kg (3.3 lbs)  
 Stripped Weight: 1.04 kg (2.3 lbs)  
 Vol: 34.4 L (2100 cu-in)  
 Size:  S/M  L/XL

### SCEPTER 50

Weight: 1.59 kg (3.5 lbs)  
 Stripped Weight: 1.13 kg (2.5 lbs)  
 Vol: 51 L (3110 cu-in)  
 Size:  S/M  L/XL



Black Scepter 35    Black Scepter 50    Techno Scepter 35    Techno Scepter 50

# TOWER 47

From its burly fabrication and splay-open access to its removable components and comfortable carry, this is an organizational monster. This is the perfect crag pack with the functions climbers need.

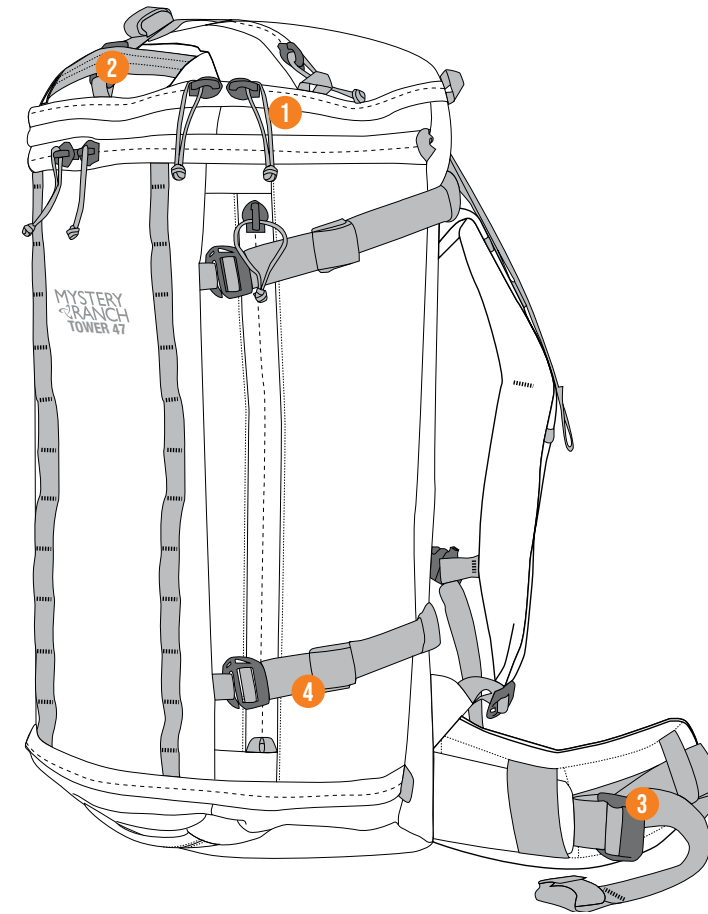

## KEY FEATURES:

- 1 Top zippered opening for controlled access or duffel bag opening for full access to gear
- 2 Handles on top for hauling, handles on the side and bottom for easily moving the bag when open
- 3 Removable Alpine waist belt
- 4 Removable compression straps with aluminum buckles
  - Telescoping Alpine yoke for custom torso fit (can be removed)

## SPECS:

Weight: 2 kg (4.4 lbs)  
 Vol: 47 L (2868 cu-in)  
 Size:  S/M  L/XL



Black

# SKYLINE 17

This pack is small in stature, simple, and flexible. It's the perfect bag to be worn for a few pitches or dragged up through tight chimneys.

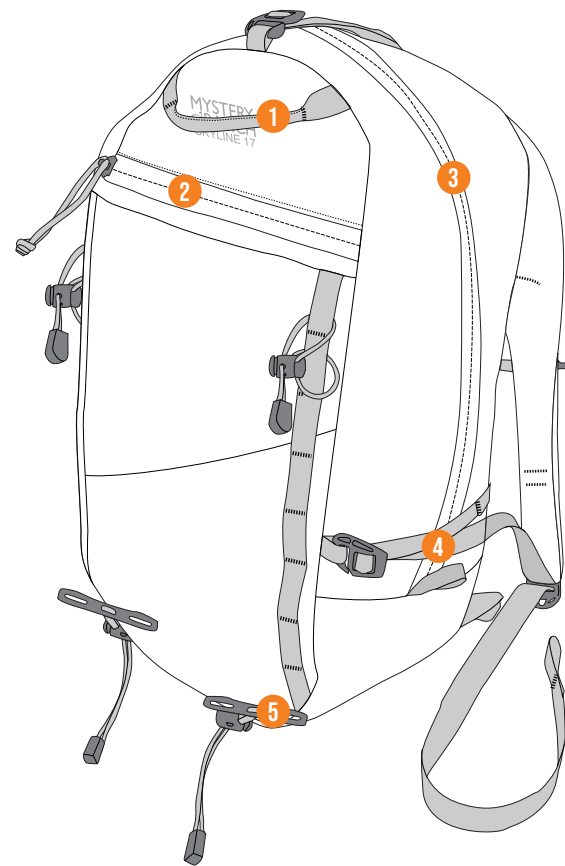

## KEY FEATURES:

- 1 Double haul loops
- 2 External zippered pocket
- 3 Zippered panel access with gussets to prevent spillage
- 4 Three (top and sides) removable compression straps for exterior rope carry
- 5 Removable tool attach

## SPECS:

Weight: 0.6 kg (1.4 lb)  
 Vol: 17 L (1037 cu-in)  
 Size: One Size



Black

Splash

# SKYLINE 23

This pack is perfect for climbers with a bit more to carry – or for taller climbers. The rip-zip opening is great for quick, ample access without having to fear the loss of any equipment.

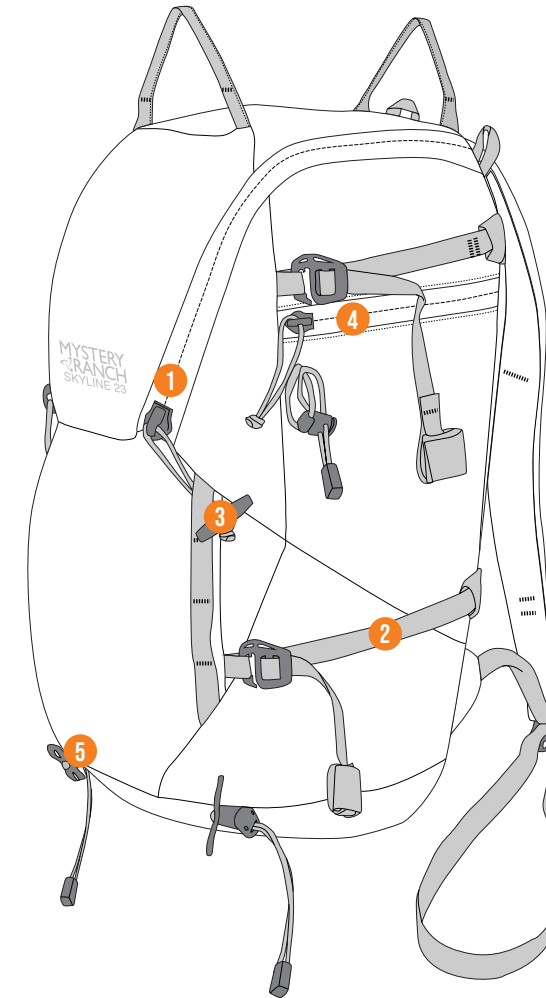

## KEY FEATURES:

- 1 Quick rip-zip panel access
- 2 Five removable compression straps for exterior rope carry
- 3 Toggle-locking zipper sliders
- 4 External zippered pocket on side
- 5 Removable tool attach

## SPECS:

Weight: 0.7 kg (1.6 lb)  
 Vol: 23 L (1403 cu-in)  
 Size: One Size



Black

Splash



# SNOW PACKS

For dawn patrol trips into the backcountry or laps at the resort, **MYSTERY RANCH snowpacks** are built to carry your essentials.

These burly packs can handle any extra load, from avy equipment to extra layers and all the snacks.





# GALLATIN PEAK 40

A pack built for safety, the GALLATIN PEAK 40 features multiple carry options for ski, splitboard, or snowboard, plus glove-friendly buckles. It's a pack that ski patrollers, guides, and backcountry enthusiasts love.

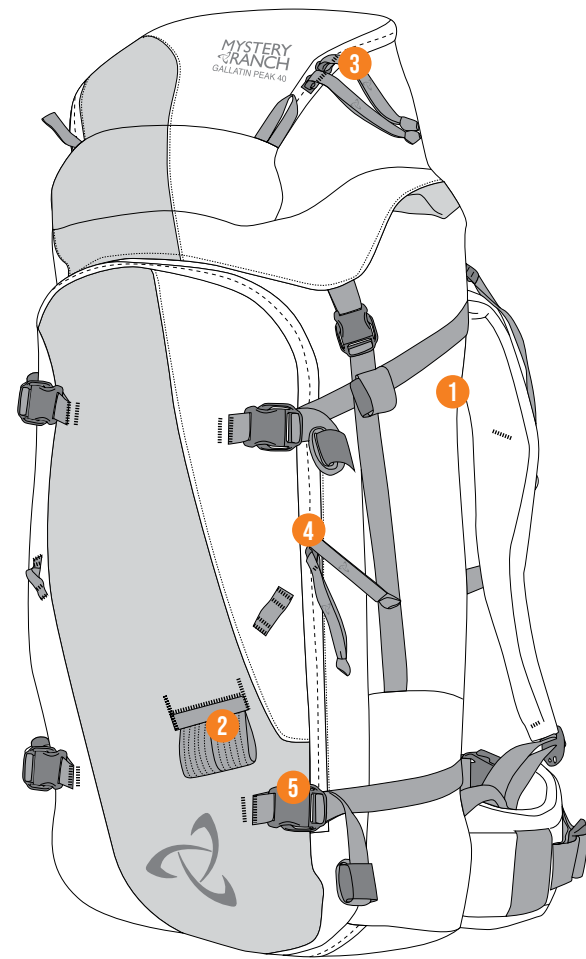

## KEY FEATURES:

- 1 Body panel unzips to allow easy, on-the-fly access to the main bag while skis are attached
- 2 Stout stowable ski loop for stable diagonal ski carry
- 3 Two zippered lid pockets (one soft, fabric-lined for storing goggles)
- 4 Zipper access to large, organized Avy pocket
- 5 Glove-friendly buckles
  - Top-loading compartment with shroud
  - Exterior, tuck-away helmet carry

## SPECS:

Weight: 1.74 kg (3 lbs)  
Vol: 42.2 L (2575 cu-in)  
Size:  S/M  L/XL



Black

The MYSTERY RANCH ski packs are built with a durable 320D NP Phantom Ripstop and YKK® zippers throughout. All the packs feature a reinforced panel of 840D Nylon treated with heavy-duty Carbonite coating to deflect sharp ski edges when utilizing the stowable ski loops for diagonal ski carry. The body panel unzips to allow easy, on-the-fly access to the main bag when skis are attached, and the buckles are specifically designed to be used with gloves.

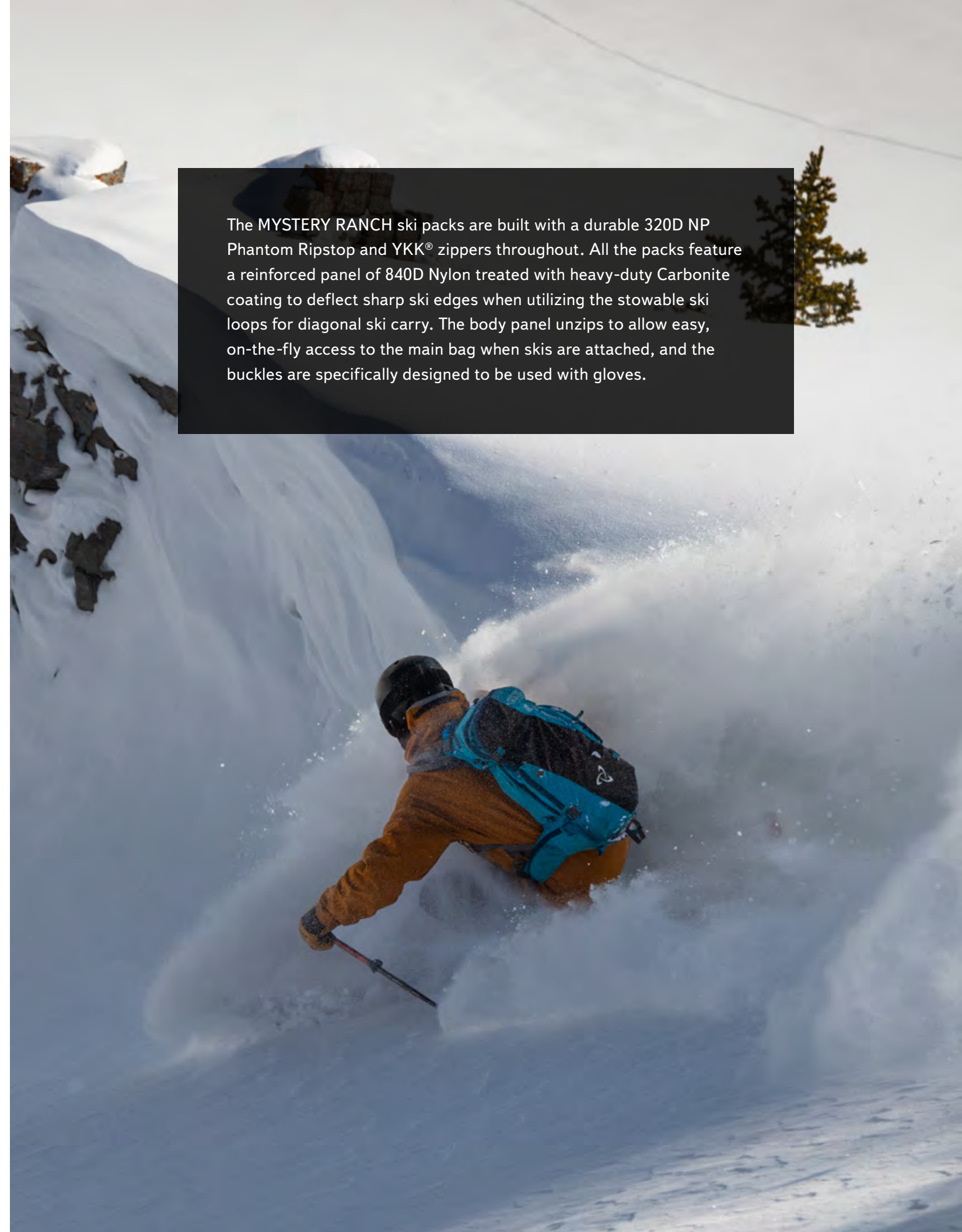



# SADDLE PEAK

Resort or backcountry, this super comfortable and super durable pack is trusted by ski patrol and ski bums alike. Fast access to Avy gear or goggles, glove-friendly buckles, and water shedding capabilities – this pack is a skier’s dream.

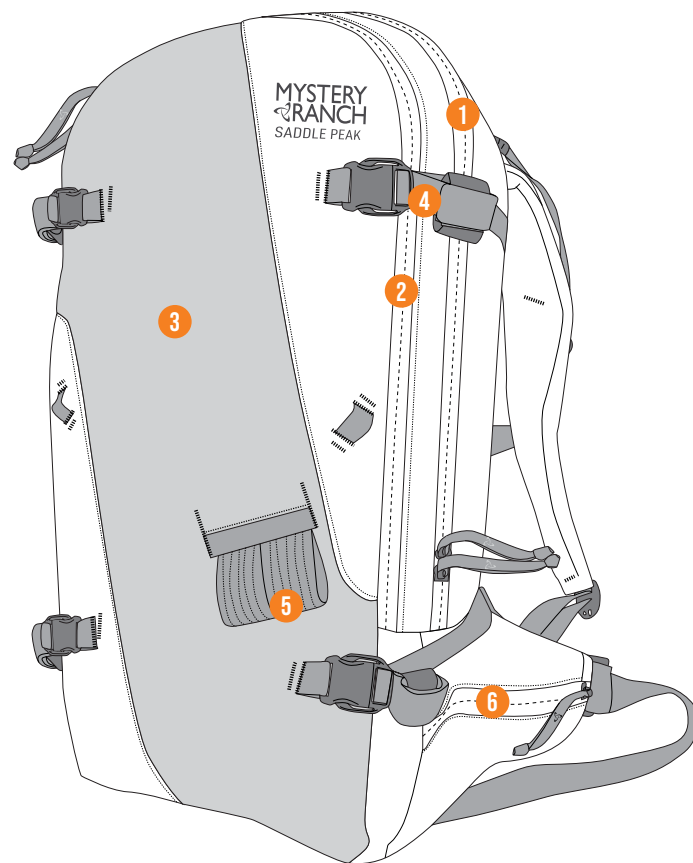

## KEY FEATURES:

- 1 Zippered access into the main bag
- 2 Zipper access to large, organized Avy pocket
- 3 840D face with carbonate coating for extra abrasion resistance
- 4 Compression straps with glove-friendly buckles
- 5 Stout/stowable ski loop for stable diagonal ski carry
- 6 Pocketed waist belt for quick access to snacks or tools
  - Top zippered lid pocket lined with soft fabric for storing goggles
  - Exterior, tuck-away helmet carry
  - Hydration reservoir compatible

## SPECS:

Weight: 1.35 kg (2.96 lbs)  
 Vol: 25.5 L (1555 cu-in)  
 Size: S/M L/XL



Black



Techno

# D-ROUTE

When your mission is a pre-work powder line in the backcountry, the D-ROUTE is a trim, glove-friendly ski pack for lapping in or near bounds. The pack keeps you prepared with your shovel, probe, and other key essentials.

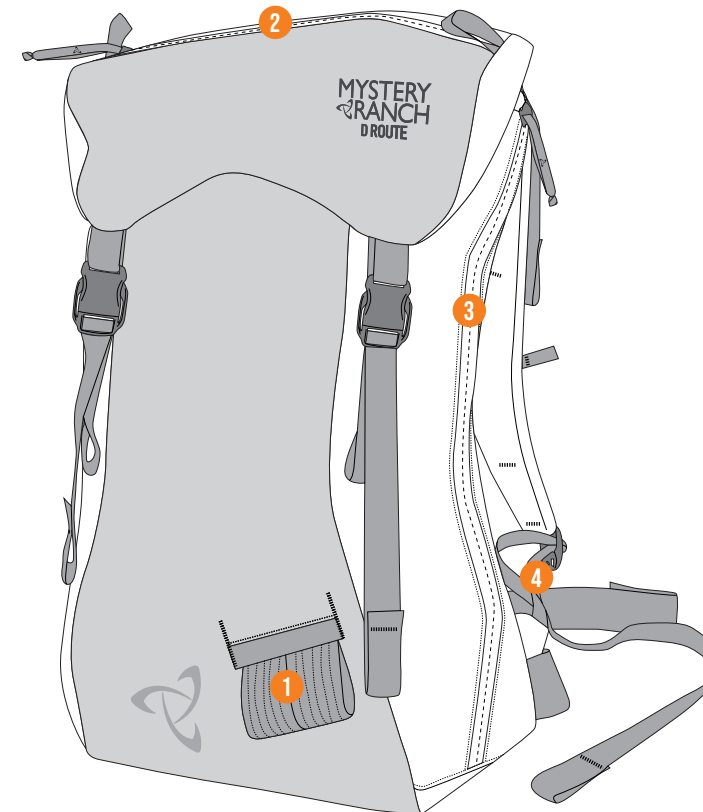

## KEY FEATURES:

- 1 Stout/stowable ski loop for stable diagonal ski carry
- 2 Lined lid pocket to protect goggles from getting scratched
- 3 Side zip to allow easy, on-the-fly access to the main bag while skis are attached
- 4 Fixed harnessing and webbing waist belt
  - Top-loading shroud access to main compartment with lid
  - Hydration reservoir compatible

## SPECS:

Weight: 0.76 kg (1.56 lbs)  
 Vol: 17.2 L (1050 cu-in)  
 Size: One Size



Black



Lizard



Techno





# EVERYDAY CARRY

Not all adventures are in the mountains. **MYSTERY RANCH** has packs for every kind of adventure — even the everyday kind.

Whether it's work, school, or a quick trip to the market, these bags will support everything from computers and books to groceries.



# DISTRICT 24

This 24-liter pack offers the same notable features as the 18 but fits a 17" laptop and has a little extra room for whatever is essential for the day. Go ahead, take more.

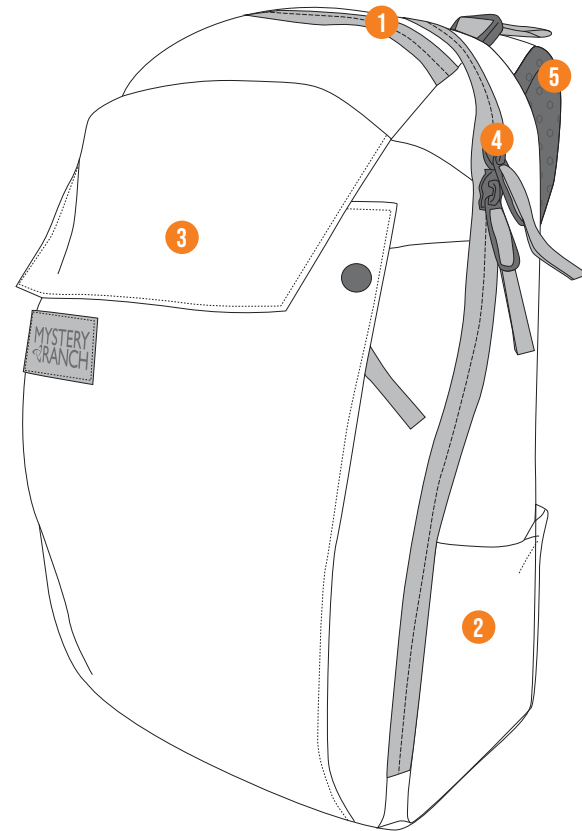

## KEY FEATURES:

- 1 Zippered top pocket with integrated key clip
- 2 Dual stretch-woven side bottle pockets
- 3 Front pocket with quick hook-and-loop access and side zip for full access
- 4 Horseshoe shaped zippered access to roomy main compartment with ample organization
  - Internal divider with two detail pockets
  - Made with partially recycled materials
  - Protective padded, floating sleeve that fits a 17" laptop
- 5 Open cell foam padded shoulder pads and body panel



## SPECS:

Weight: 1.24 kg (2.74 lbs)  
 Vol: 23 L (1405 cu-in)  
 Size: One Size



Black Hummus Galaxy Mineral Gray

# DISTRICT 18

This fixed-harness pack blends style, function, and durability. A top admin pocket, dual-side water bottle pockets, and a padded tablet or laptop sleeve makes for a perfect companion for any kind of commute.

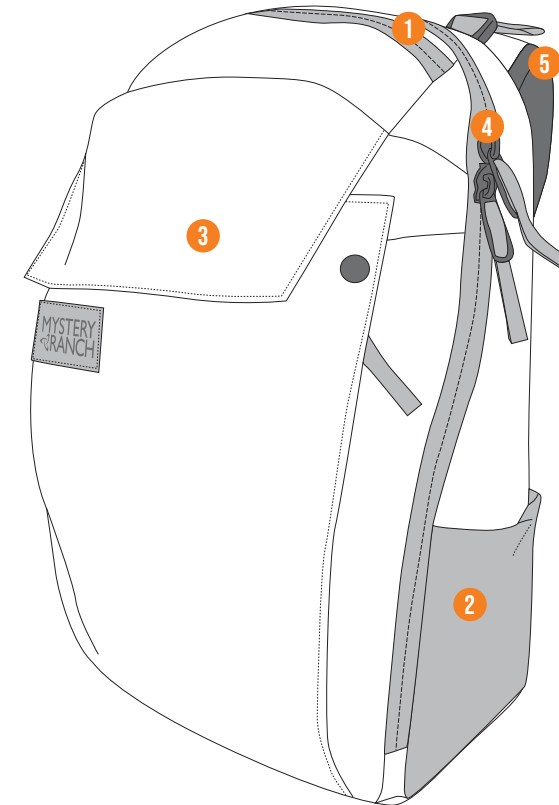

## KEY FEATURES:

- 1 Zippered top pocket with integrated key clip
- 2 Two stretch-woven side bottle pockets
- 3 Front pocket with quick hook-and-loop access and side zip for full access
- 4 Horseshoe shaped zippered access to roomy main compartment with ample organization
  - Internal divider with two detail pockets
  - Made with partially recycled materials
  - Protective padded, floating sleeve that fits a 15" laptop
- 5 Open cell foam padded shoulder pads and body panel



## SPECS:

Weight: 1.16 kg (2.56 lbs)  
 Vol: 18.9 L (1155 cu-in)  
 Size: One Size



Black Aura Galaxy Sunset



# DISTRICT 8

Not quite a messenger bag, not quite a hip pack – the DISTRICT 8 is the perfect in-between for when a tablet, battery bank, phone, water bottle, and extra layer all need a home.



## KEY FEATURES:

- 1 Adjustable ambidextrous shoulder straps
- 2 Quick-release buckle
- 3 Multiple pocket options and internal divider for organization
  - Body panel electronics pocket
  - Made with partially recycled materials



## SPECS:

Weight: 0.48 kg (1.05 lbs)  
 Vol: 7.5 L (460 cu-in)  
 Size: One Size

Aura, Black, Hummus, Mineral Gray



# DISTRICT 4 & 2

These sleek, recycled shoulder bags are a minimalist's dream. Both feature thoughtful pockets and space to carry phones, wallets, and small essentials – we leave it up to you to decide how minimal you want to be.

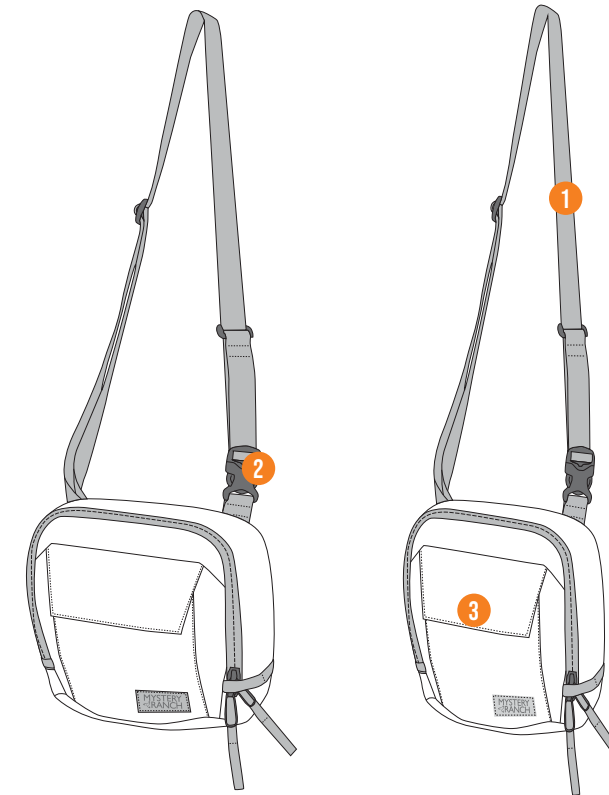

## KEY FEATURES:

- 1 Adjustable straps make it easy to be worn over the shoulder or on the hip
- 2 Quick-release buckles
- 3 Multiple pocket options and organization
  - Made with partially recycled materials
  - Body panel phone pocket



## SPECS:

### DISTRICT 4

Weight: 0.29 kg (0.63 lb)  
 Vol: 4 L (245 cu-in)  
 Size: One Size

### DISTRICT 2

Weight: 0.22 kg (0.49 lb)  
 Vol: 2 L (120 cu-in)  
 Size: One Size



# BLITZ 35

Whether you're at work, school, or in the middle of nowhere, this top-loading tank of a pack is perfect for your everyday mission. Side zip access and plenty of pockets allow you to be organized for your commute to the office or overlanding.

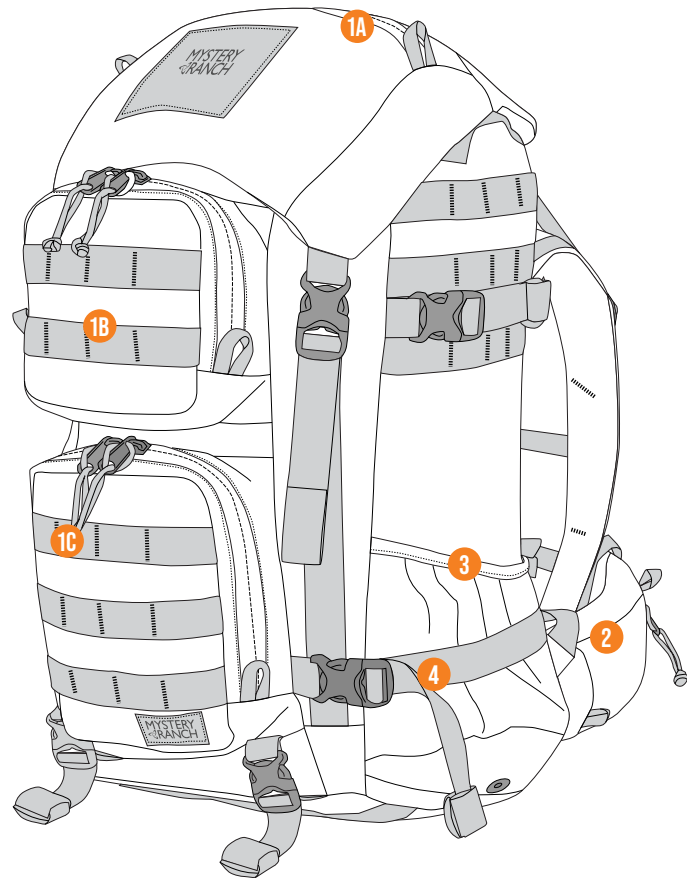

## KEY FEATURES:

- 1 Three main (ABC) pockets and ample PALS webbing
- 2 Removable pocketed waist belt
- 3 Side pocket
- 4 Side and lower compression straps
  - Padded, floating laptop sleeve
  - Top loader with zipper access

## SPECS:

Weight: 2 kg (4.4 lbs)  
 Vol: 35.8 L (2185 cu-in)  
 Size: S/M L/XL



Coyote

Forest

Black

# BLITZ 30

The go-to bag that offers a tactical solution to your everyday needs. With full horseshoe-style zip access, work-rich features, and a hydro-ported body panel, the pack can go from the office to off-road in a hurry.



## KEY FEATURES:

- 1 Three main (ABC) pockets and ample PALS webbing
- 2 Full horseshoe-style zip access with wrap-around zipper panel
- 3 Side pocket
- 4 Side and lower compression straps
  - Zippered access to laptop sleeve from body panel
  - Removable webbing waist belt
  - Padded, floating laptop sleeve

## SPECS:

Weight: 1.7 kg (3.8 lbs)  
 Vol: 29 L (1770 cu-in)  
 Size: S/M L/XL



Coyote

Forest

Black



# 3 WAY 18

This briefcase lives at the intersection of your commuting needs, doubling as a shoulder bag, transforming into a backpack, and doing it all with environmentally conscious organizational wizardry.



## KEY FEATURES:

- 1 Front rip-zip pocket with magnetic buckle, mesh zippered pocket, and stretch fabric detail pockets
  - 2 Expandable zipper design creates five more liters of space
  - 3 Removable shoulder strap for switching back to briefcase or shoulder bag
- Main compartment has stretch woven detail pockets backed with soft material for headphones
  - Additional divider in the main compartment with a zippered pocket and stretch detail pockets
  - Body panel pocket has padded laptop sleeve (fits laptops up to 15"), and a dump pouch with detail pockets
  - Luggage handle slot on the body panel
  - Made with partially recycled materials



## SPECS:

Weight: 1.27 kg (2.74 lbs)  
 Vol: 2.7 L (1100 cu-in)  
 Size: One Size



Black Sagebrush Shadow



Tiger's Eye Wildfire Black

# 3 WAY 27

It's a briefcase! It's a shoulder bag! It's a backpack! It's...all three? Yep, the 3 Way 27 is bigger, roomier, and more environmentally friendly than ever.

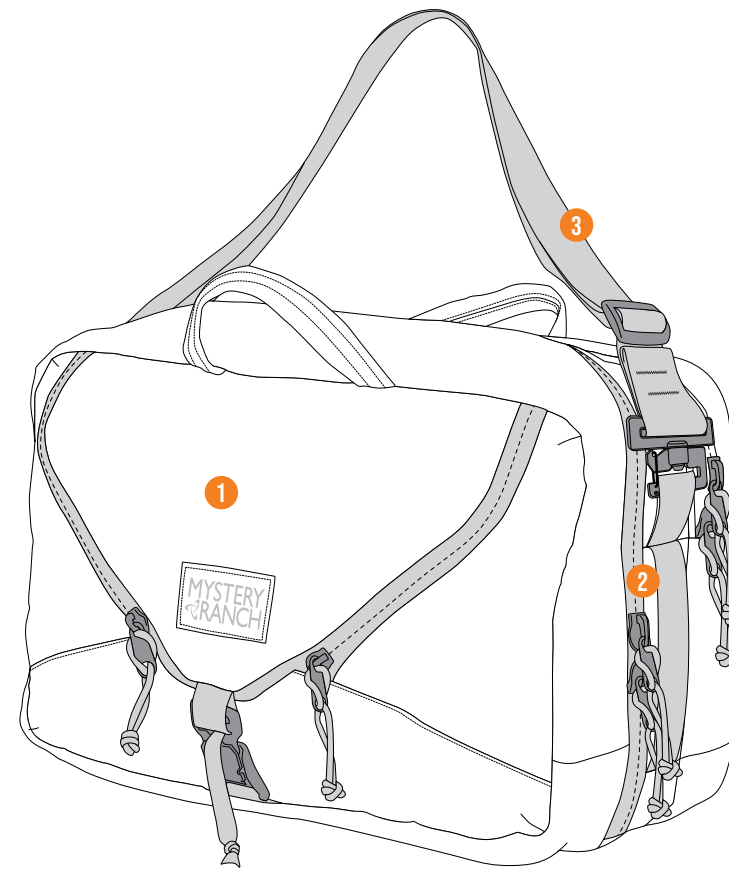

## KEY FEATURES:

- 1 Front rip-zip pocket with magnetic buckle, mesh zippered pocket, and stretch fabric detail pockets
  - 2 Clam shell opening to the main compartment for easy access and an elastic retention band
  - 3 Removable shoulder strap for switching back to briefcase or shoulder bag
- Main compartment has stretch woven detail pockets backed with soft material for headphones
  - Body panel pocket has padded laptop sleeve (fits laptops up to 17"), and a dump pouch with detail pockets
  - Luggage handle slot on the body panel
  - Made with partially recycled materials



## SPECS:

Weight: 1.41 kg (3.1 lbs)  
 Vol: 27 L (1650 cu-in)  
 Size: One Size



Black Sagebrush



Shadow Tiger's Eye

# CATALYST 18

This super functional pack was made to handle whatever your everyday mission throws at you. With its tough yet environmentally friendly CORDURA® body, it's up for outdoor adventures too.

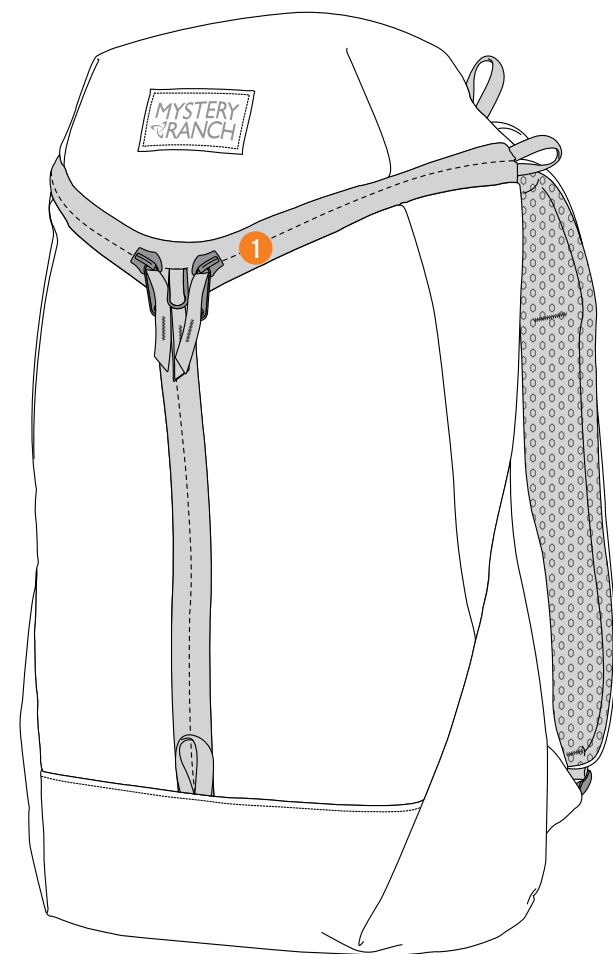

## KEY FEATURES:

- 1 3-ZIP design for rapid access to interior
  - Padded laptop pocket with elastic holds laptops up to 15" in size
  - Additional sleeve on the front of the laptop pocket holds a tablet, notebooks, maps, etc.
  - Two internal zippered pockets to hold those small-but-important items
  - Made with partially recycled materials



## SPECS:

Weight: 0.8 kg (1.8 lbs)  
 Vol: 18 L (1098 cu-in)  
 Size: One Size



# CATALYST 22

You don't have to compromise with this tough yet eco-friendly backpack. The CATALYST 22 can be used both in the office and on the trail.



## KEY FEATURES:

- 1 3-ZIP design for rapid access to interior
- 2 Two external water bottle pockets, one on each side, fit most bottles
  - Additional sleeve on the front of the laptop pocket holds a tablet, notebooks, maps, etc.
  - Two internal zippered pockets to hold those small-but-important items
  - Padded laptop pocket with elastic holds laptops up to 16" in size
  - Made with partially recycled materials



## SPECS:

Weight: 1 kg (2.16 lbs)  
 Vol: 21 L (1280 cu-in)  
 Size: One Size





# CATALYST 26

A versatile pack built to withstand any urban adventure. With its tough yet environmentally friendly CORDURA® body, it's ready for the outdoors too.

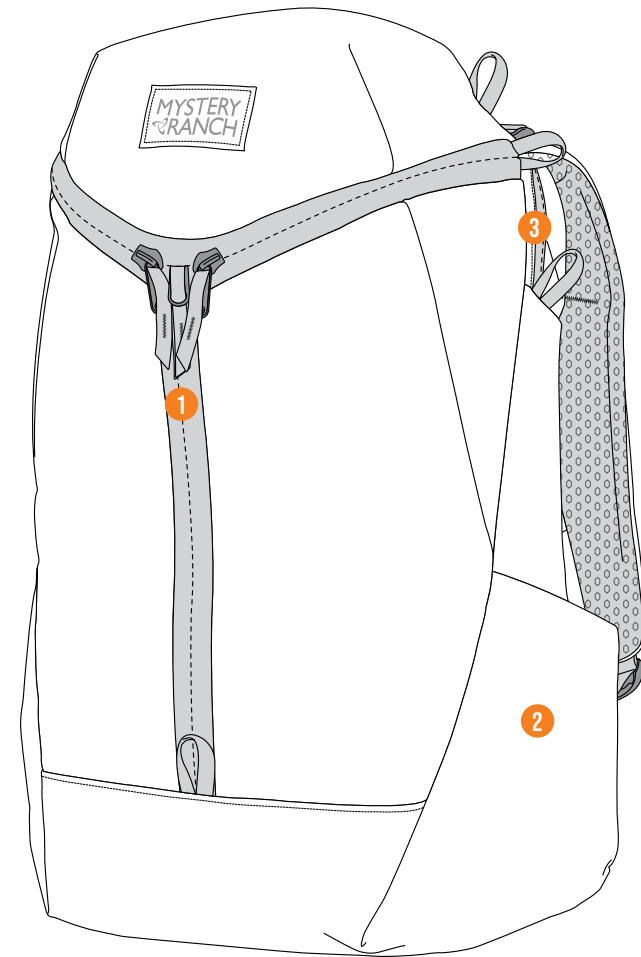

## KEY FEATURES:

- 1 3-ZIP design for rapid access to interior
- 2 Two external water bottle pockets, one on each side, fit most bottles
- 3 Dedicated zippered padded laptop pocket with a divider to hold both a laptop (up to 17") and tablet
  - Organizational sleeve on the inside of the bag includes a small, zippered mesh pocket, a dump pocket for a charging cord or water bottle, and two rows of elastic to hold pens, wires, or pocket knives
  - Two internal zippered pockets to hold those small-but-important items
  - Made with partially recycled materials



## SPECS:

Weight: 1.16 kg (2.56 lbs)  
 Vol: 25.8 L (1575 cu-in)  
 Size: One Size



# 2-DAY ASSAULT

From the aspiring to retired gunfighters, the 2-DAY is MYSTERY RANCH's nod to the ultra-success of the 3-Day Assault Pack. The 2-DAY is a scaled-down option for non-military enthusiasts built into a smaller, everyday urban size and functionality.

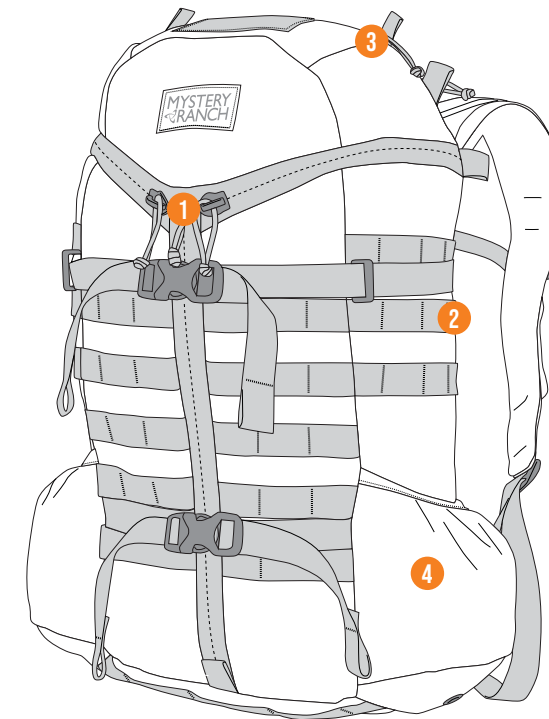

## KEY FEATURES:

- 1 Classic 3-ZIP design for easy, rapid access to the interior
- 2 Main compartment and body panel zip access to a document/tablet sleeve pocket and a floating, padded sleeve that fits laptops up to 15"
- 3 Two zippered lid pockets with loop panel on top of lid for morale patches
- 4 External bottle pockets
  - Interior dump pockets
  - Removable web waistbelt
  - Adjustable yoke

## SPECS:

Weight: 1.4 kg (3 lbs)  
 Vol: 29.7 L (1810 cu-in)  
 Size:  S/M  L/XL



# RIP RUCK 15

The smallest in the RIP RUCK series, this pack has a main rip-zip compartment that has a laptop and document sleeve, a zippered mesh pocket, and two internal side pockets. Its minimalist, low profile design will make any commute less of a hassle.

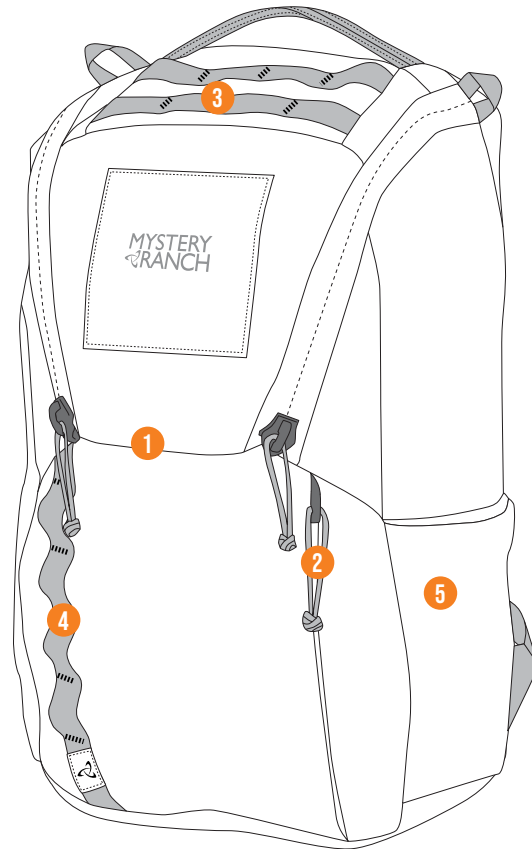

## KEY FEATURES:

- 1 Quick rip-zip panel access to drop in compartment for easy one handed open and close that is secured with magnets
- 2 Vertical entry zippered face pocket with interior dividers
- 3 PALS webbing on top of lid for MOLLE accessories
- 4 Daisy chain on face of pack
- 5 Side stretch pocket
  - Floating padded sleeve with Velcro closure fits laptops up to 15"
  - Additional document sleeve is lined with loop panel for attaching accessories

## SPECS:

Weight: 0.7 kg (1.6 lb)  
 Vol: 15 L (915 cu-in)  
 Sizes: One Size



Black Foliage Forest Wood

# RIP RUCK 24

The mid-size pack in the RIP RUCK series, will be your best travel companion because of its organization. It has two main compartments: a zip access to a separate laptop and document sleeve and a rip-zip compartment that has a sleeve, zippered mesh pocket, and plenty of space for all your other must-haves.

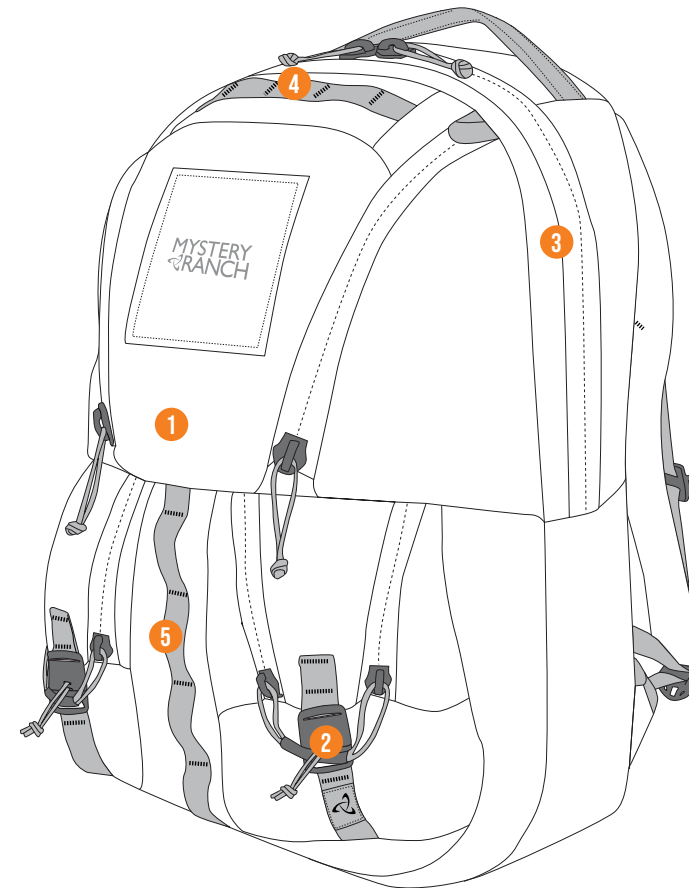

## KEY FEATURES:

- 1 Quick rip-zip panel access to drop in compartment for easy one handed open and close that is secured with magnets
- 2 Two lower rip-zip pockets with quick pull magnetic open and close
- 3 Vertical entry zippered face pocket with interior dividers
- 4 PALS webbing on top of lid for MOLLE accessories
- 5 Daisy chain on face of pack
  - Floating padded sleeve with Velcro closure fits laptops up to 15"
  - Additional document sleeve is lined with loop panel for attaching accessories
  - An additional pocket on the padded floating computer sleeve has a full panel with Velcro for attaching accessories

## SPECS:

Weight: 1.0 kg (2.3 lbs)  
 Vol: 24 L (1465 cu-in)  
 Sizes: One Size



Black Foliage Forest Wood



# RIP RUCK 32

Inspired by the military ALICE RUCK, the RIP RUCK 32 is the largest of the series. This Swiss Army knife of a pack is full of pockets and organizational features that work well for travel, the office, and everywhere in between.

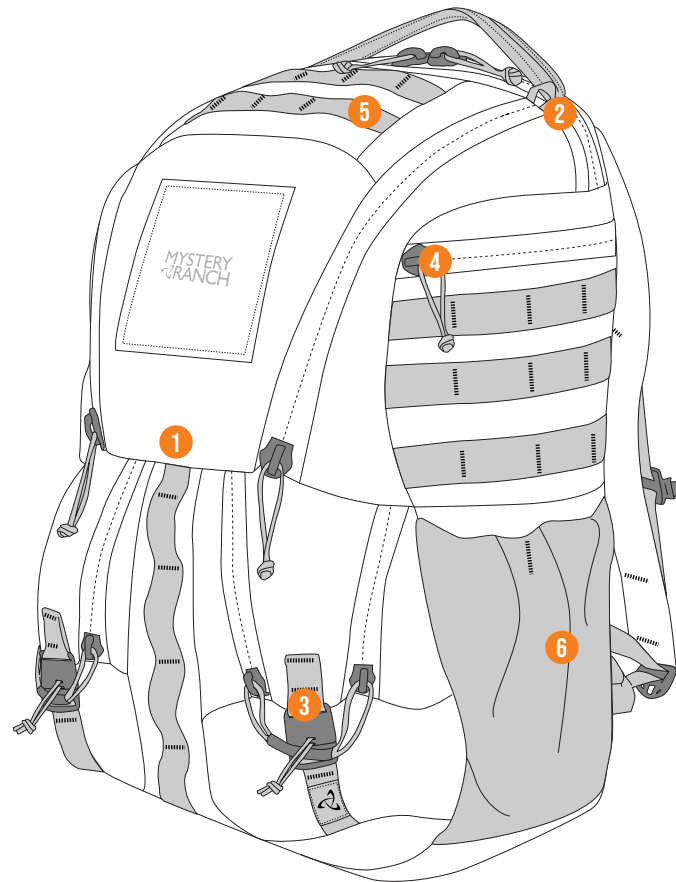

## KEY FEATURES:

- 1 Quick rip-zip panel access to drop-in compartment for easy one-handed open and close that is secured with magnets
- 2 Top zip access to separate laptop and document compartment (fits laptop up to 15")
- 3 Two lower rip-zip pockets with quick-pull magnetic open and close
- 4 Two, upper exterior zipper pockets
- 5 Side stretch pockets
- 6 MOLLE on top of lid and across the sides
  - Rip-zip compartment has divided, zippered mesh pocket and document sleeve
  - Stowable waist belt tucks into compartments beneath the water bottle pockets when not in use

## SPECS:

Weight: 1.7 kg (3.8 lbs)  
 Vol: 32 L (1955 cu-in)  
 Size: S/M L/XL



Black

Foliage

Wood

# SUPERSET 30

A gym bag that you can choose how to use. This highly versatile bag meets your ever-changing needs with deployable shoulder pads, side grab handles, and body panel zip access.

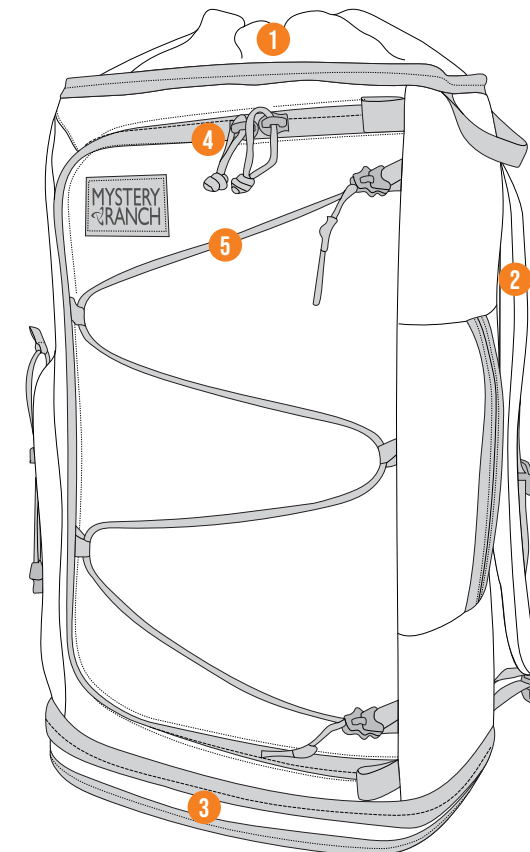

## KEY FEATURES:

- 1 Multiple access points to the main bag via duffel style opening or top-loading shroud
- 2 Stowable, padded shoulder pads
- 3 Zippered boot compartment for shoes or dirty gym clothes
- 4 Large, zippered pocket with internal mesh and stretch pockets for small necessities
- 5 Bungee cord to stash extra layers or a yoga mat
  - Large, zippered back pocket
  - Internal computer sleeve and a separate compartment on the bottom of the bag

## SPECS:

Weight: 1 kg (2.28 lbs)  
 Vol: 27.8 L (1695 cu-in)  
 Size: One Size



Black

Splash

Steel

# BINDLE 10 & 20

From the grocery store to the office, this EDC classic offers ample room for even the non-essentials. The BINDLE comes in two sizes, is top-zippered, and features a body structure that stands upright and open on its own.

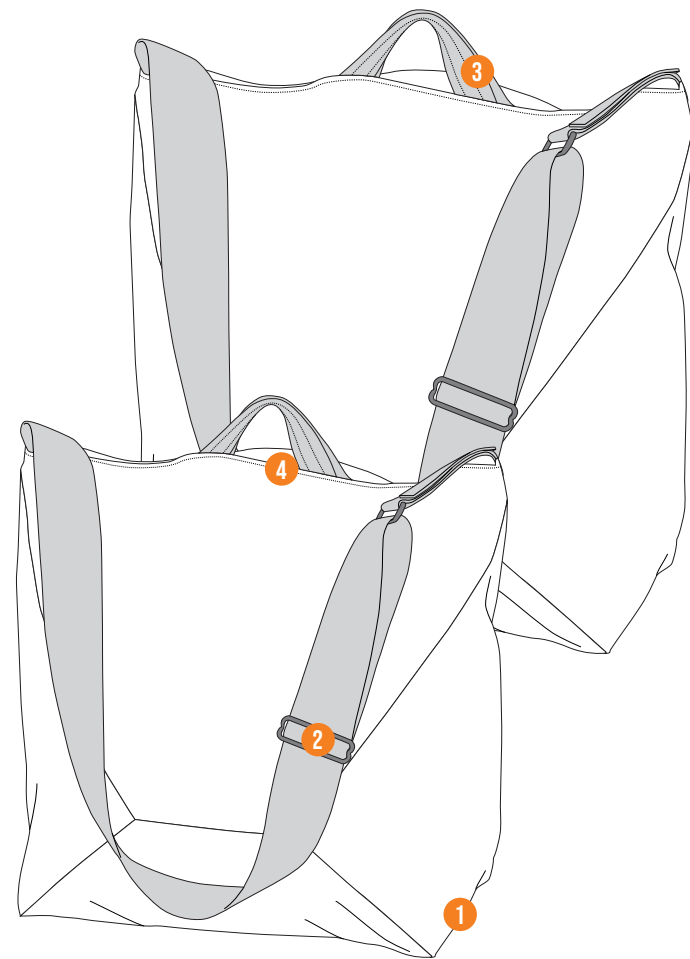

## KEY FEATURES:

- 1 Boxy structure designed to stay upright and open when on the ground
- 2 1.5" adjustable webbing shoulder strap distributes the weight
- 3 Soft yet strong webbing handles for carry
- 4 Double-snap closure secures contents
  - Key clip on long leash makes digging in the bottom of your bag a thing of the past

## SPECS:

### BINDLE 10

Weight: 0.44 kg (0.97 lb)  
 Vol: 10.4 L (635 cu-in)  
 Size: One Size

### BINDLE 20

Weight: 0.86 kg (1.5 lb)  
 Vol: 20.8 L (1270 cu-in)  
 Size: One Size



Black

Conifer

Indigo

# STREET MARKET

Compact enough to include in your international luggage yet stylish enough for dinner out on the town, this small, thoughtfully designed bag offers the durability you'd expect from a MYSTERY RANCH bag.



## KEY FEATURES:

- 1 Zippered main access
- 2 Zippered pocket on body side of bag
- 3 Divided front mesh pockets
- 4 Adjustable shoulder strap
  - Soft brushed main fabric with divided internal pocket with key clip on a long leash

## SPECS:

Weight: 0.2 kg (0.44 lb)  
 Vol: 3.5 L (215 cu-in)  
 Sizes: One Size



Black

DPM Camo

Forest

Garnet



Hummus

Indigo

Shadow Moon



# SUPER MARKET

It's a backpack! It's a tote bag! It's a grocery-getter! The simple design of the SUPER MARKET makes it your best buddy, your coffee shop companion, or your strolling-around-town pal – it's built for all of your adventures.

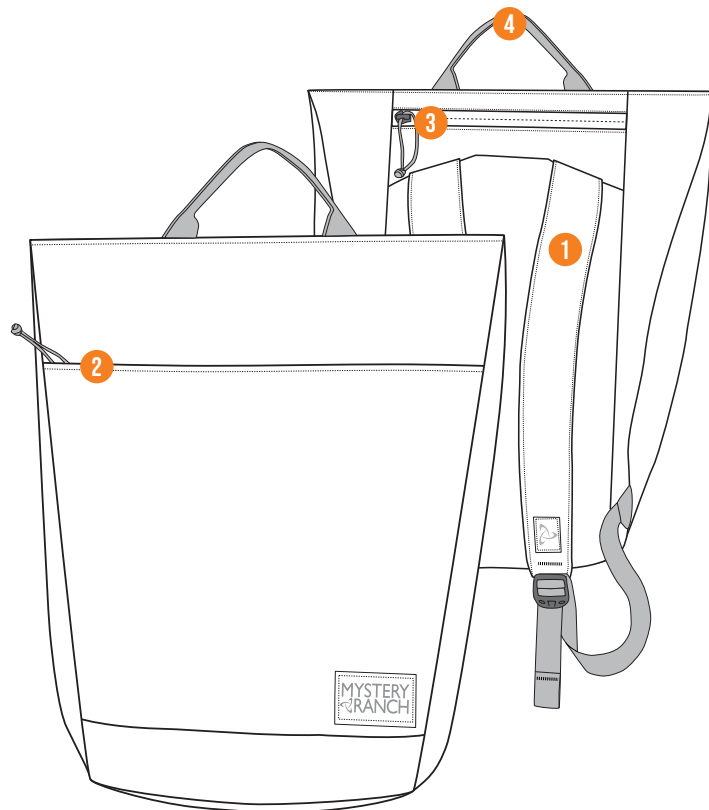

## KEY FEATURES:

- 1 Shaped, padded shoulder pad
- 2 Large front exterior zippered pocket for small items or wallet
- 3 Back exterior zippered pocket for phone or pens
- 4 Tote handles and dual main compartment closure: zipper and metal snaps
  - Floating, padded sleeve fits laptop up to 15"
  - Internal water bottle sleeve

## SPECS:

Weight: 0.54 kg (1.2 lb)  
 Vol: 22 L (1342 cu-in)  
 Sizes: One Size



# MARKET

A scaled-down version of the SUPER MARKET, the MARKET is designed with maximum portability in mind. From the farmers market to the dog park, the tote will totally cart all your necessities around on your daily excursions.

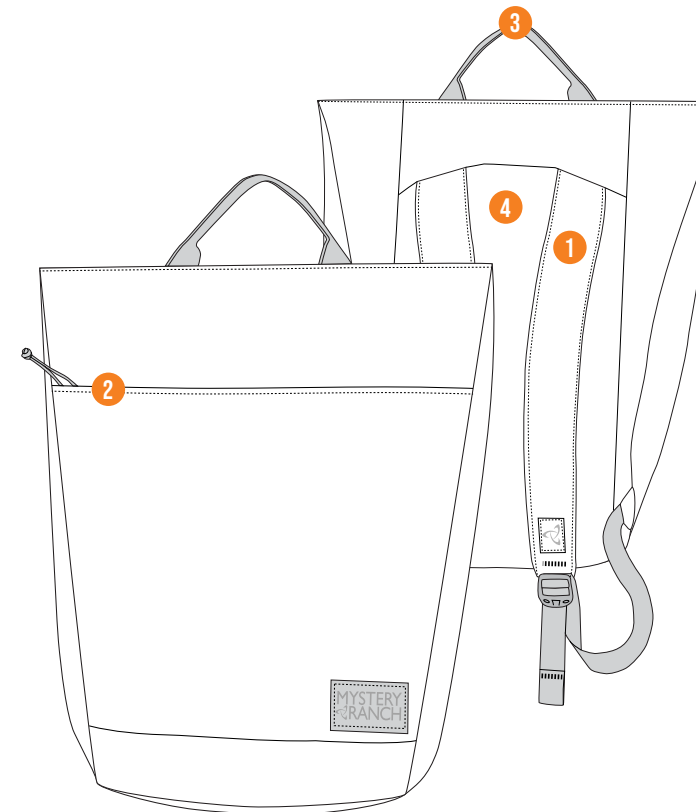

## KEY FEATURES:

- 1 Shaped, padded shoulder pad
- 2 Large front exterior zippered pocket for small items or wallet
- 3 Tote handles and dual main compartment closure: zipper and metal snaps
- 4 Foam back panel for comfort and support
  - Internal water bottle sleeve
  - Interior zippered pocket

## SPECS:

Weight: 0.45 kg (1.1 lb)  
 Vol: 18 L (1098 cu-in)  
 Sizes: One Size



# MINI MART

An ultraconvenient, mini tote bag that can serve as either a hand-bag or crossbody/shoulder bag. This petite pack keeps all your essentials close and – with a snack-sized exterior pocket – your snacks closer.

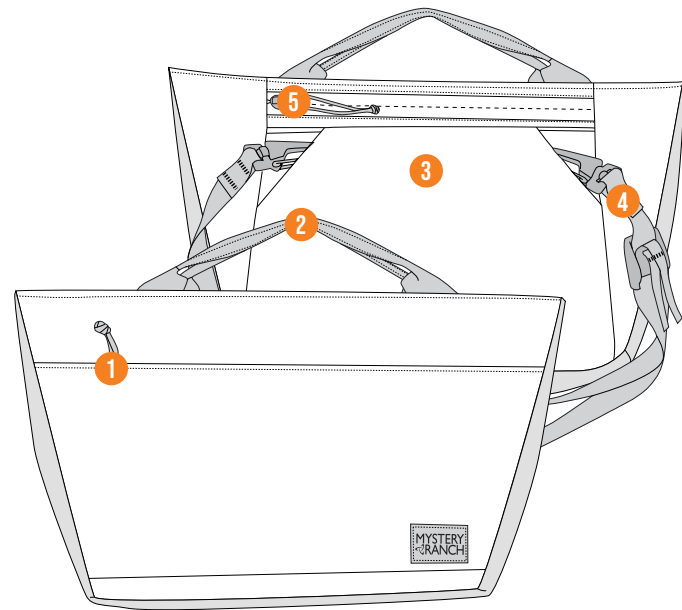

## KEY FEATURES:

- 1 Large front exterior zippered pocket for small items or wallet
- 2 Tote handles and dual main compartment closure: zipper and metal snaps
- 3 Foam back panel for comfort and support
- 4 Removable, ambidextrous, one-drop quick-adjust shoulder strap
- 5 Zippered pocket on the body panel

## SPECS:

Weight: 0.3 kg (0.7 lb)  
 Vol: 8 L (488 cu-in)  
 Sizes: One Size



Black      Forest      Garnet      Hummus

# INDIE

Built for the commuter, INDIE is a convenient shoulder bag that hauls a day's worth of stuff. This 10.5L shoulder sling provides ample room for an organized life on the move.

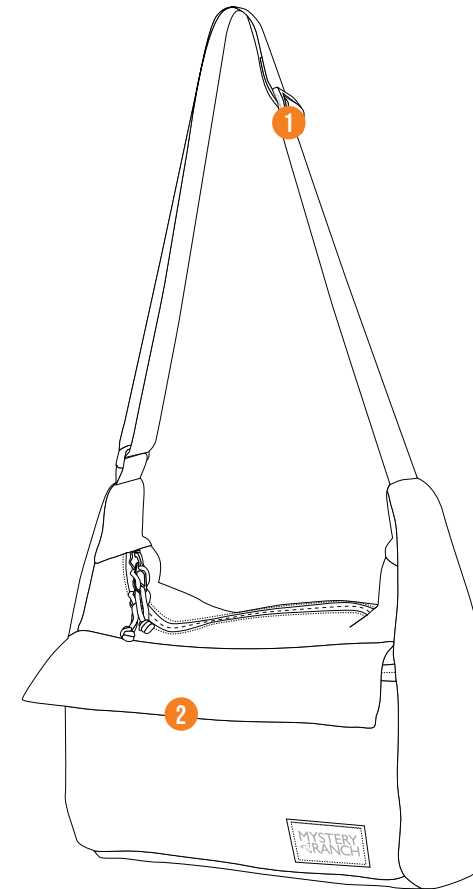

## KEY FEATURES:

- 1 Single, adjustable shoulder-carry strap
- 2 Exterior flap pocket and zippered pocket
  - Internal zippered pocket, inner divider, and key clip

## SPECS:

Weight: 0.34 kg (0.75 lb)  
 Vol: 10 L (610 cu-in)  
 Sizes: One Size



Black Robic      Hummus      Mineral Gray



# FORAGER HIP PACK

This small hip pack offers a slimmed-down option for hip or shoulder. This low-profile bag comes in an array of colors and provides a comfortable carry while making sure you have what you need close at hand.



## KEY FEATURES:

- 1 Swivel strap accommodates hip carry or over-the-shoulder carry
- 2 One hidden pocket on the body side with snap closure
- 3 One internal zippered pocket

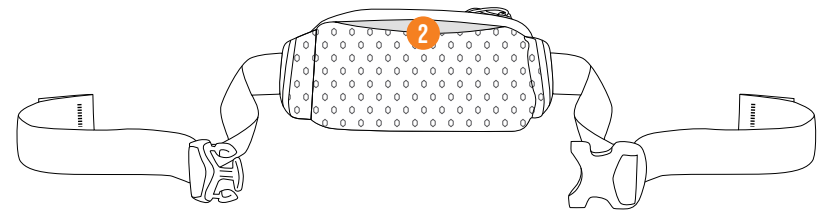

## SPECS:

Weight: 0.19 kg (0.41 lb)  
 Vol: 2.5 L (155 cu-in)  
 Dims: One Size

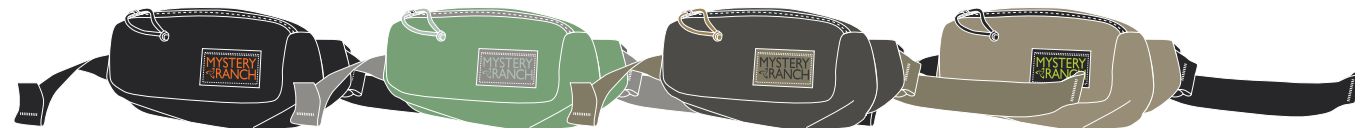

Black

Jade

Peat

Hummus Dobby



Atlantic

Aura

Sunset

Pebble

# FORAGER HIP MINI

A mini version of the FORAGER HIP PACK, this little buddy is perfect on the go when you just need your wallet, phone, and some keys. And it comes in a variety of colors to suit your mood or style.

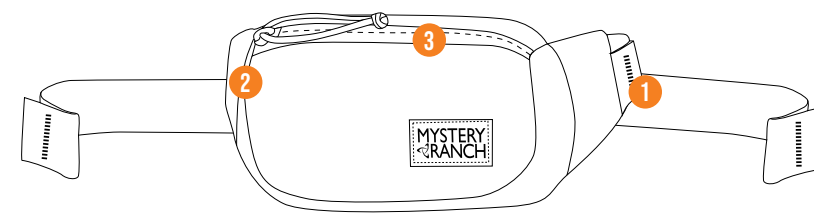

## KEY FEATURES:

- 1 Swivel strap accommodates hip carry or over-the-shoulder carry
- 2 One hidden pocket on the body side with snap closure
- 3 One internal zippered pocket

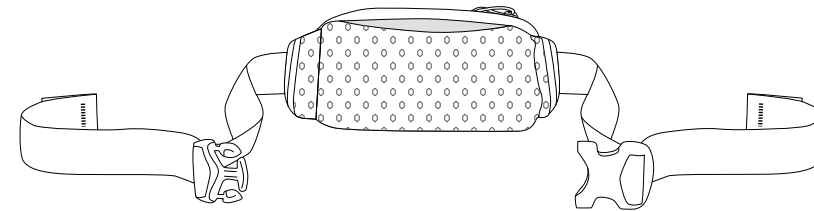

## SPECS:

Weight: 0.16 kg (0.36 lb)  
 Vol: 1.25 L (75 cu-in)  
 Dims: One Size

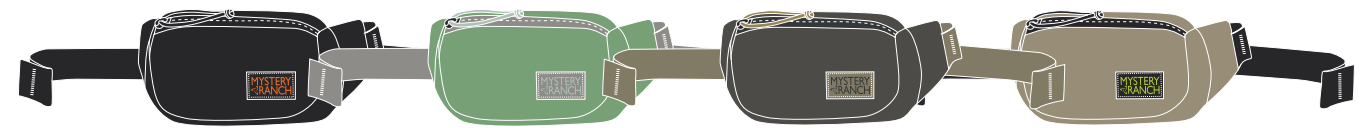

Black

Jade

Peat

Hummus Dobby

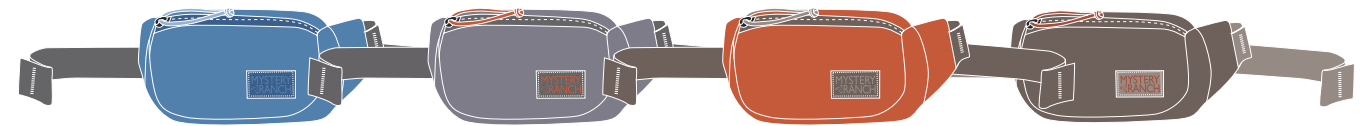

Atlantic

Aura

Sunset

Pebble

# HIP MONKEY

The HIP MONKEY's exterior is deceptively trim, but it can easily swallow an extra layer, phone, water bottle, keys, wallet, thermos, etc. It also accommodates your favorite six-pack – be it bottles or frisbee golf discs.

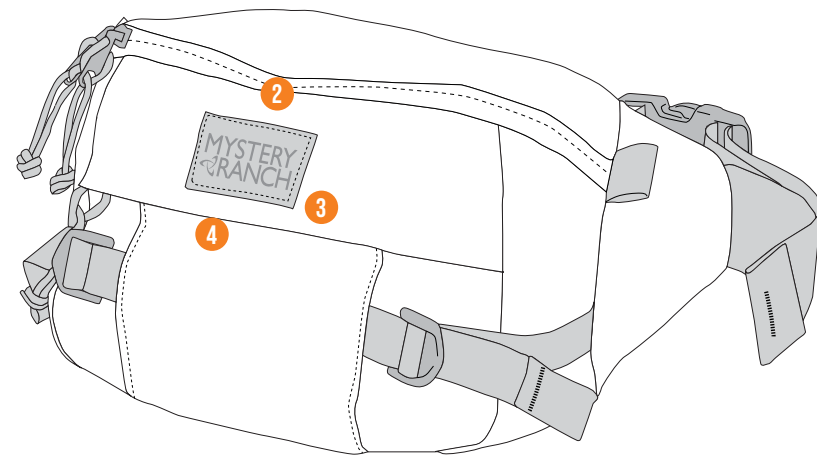

## KEY FEATURES:

- 1 Waist belt is designed for carrying around the hips or over the shoulder
- 2 Zippered access to main bag
- 3 Front pocket with key clip
- 4 Dual-compression straps

## SPECS:

Weight: 0.4 kg (0.9 lb)  
 Vol: 8 L (488 cu-in)  
 Sizes: One Size

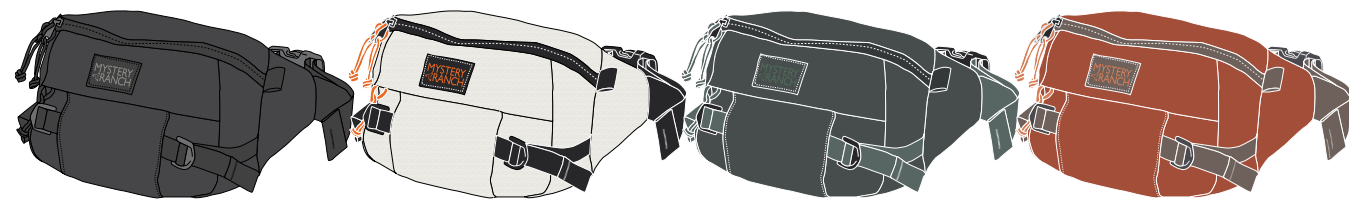

Black White Mineral Gray Paprika

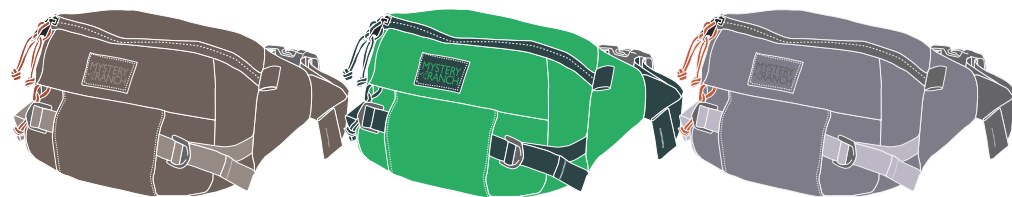

Pebble Spring Aura

# FULL MOON

This MYSTERY RANCH staff favorite is meant to keep it weird. Wear it how you want to – hip or shoulder. And it's big enough to stash everything you want to keep near and dear – and then some.



## KEY FEATURES:

- 1 Waist belt is designed for carrying around the hips or over the shoulder
- 2 Zippered access to main bag and interior zippered pockets
- 3 One large exterior zippered pocket on the front of bag
- 4 Dual-compression straps

## SPECS:

Weight: 0.4 kg (0.8 lb)  
 Vol: 6.3 L (384 cu-in)  
 Sizes: One Size

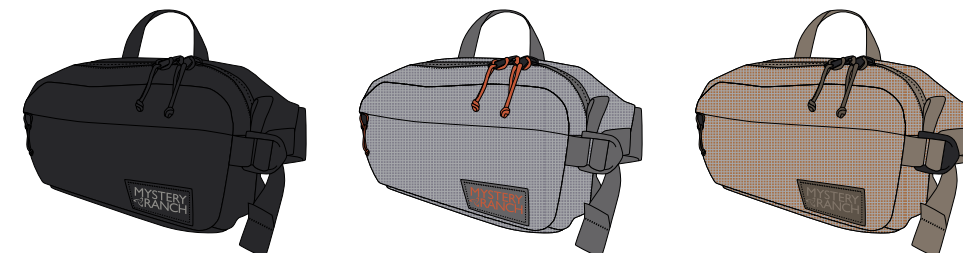

Black Aura Fox



Hummus Twig Wood Waxed





# TRAVEL

**MYSTERY RANCH has a travel pack for any mission – train, plane, or automobile.**

Rugged material and tough construction mean these bags can survive constant adventure abuse. These travel packs can haul cargo for the weekend warrior, a weeklong cross-country excursion, or an easy overnight.



# MISSION STUFFELS

Born in the same style as our MISSION DUFFEL and nesting into its own boot compartment, this convertible duffel takes up less space than a sweater when packed, making it a no-brainer to toss into your bag to accommodate the extra goodies you picked up on your trip – also freeing up floor space that traditional luggage has a hold on.

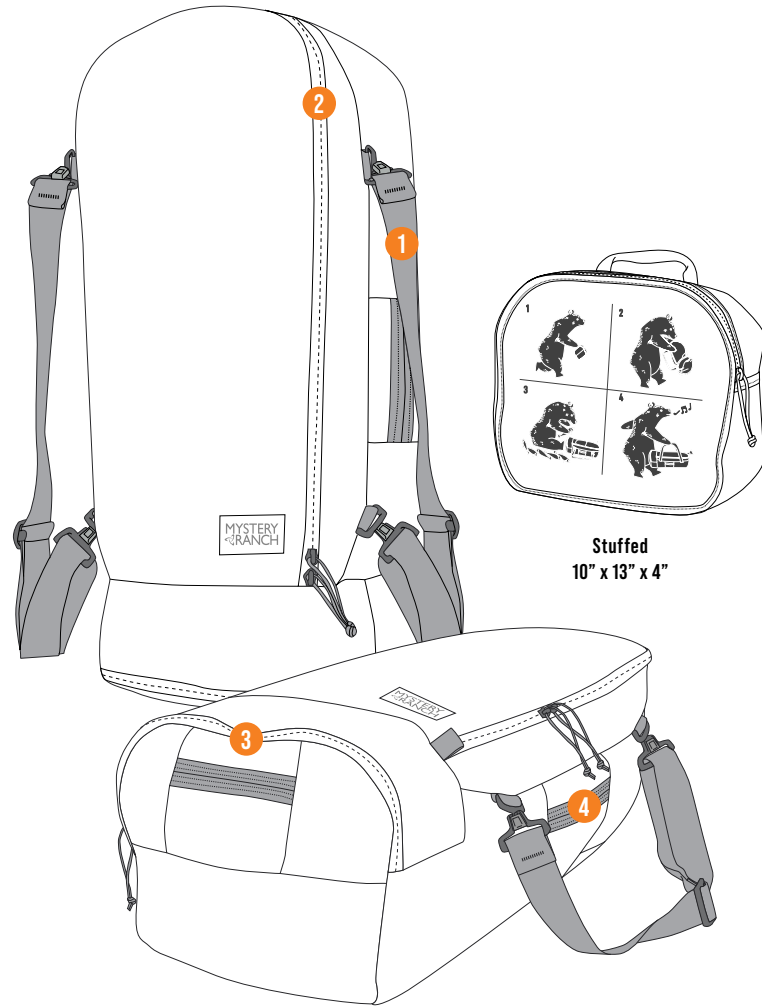

## KEY FEATURES:

- 1 Shoulder straps can be worn as a backpack or easily removed for quick storage
- 2 Huge main compartment access through a long horseshoe opening
- 3 Zippered boot compartment where pack can stuff into
- 4 A handle on all four sides

## SPECS:

- 60**
- Weight: 0.7 kg (1.53 lb)  
 Vol: 58.4 L (3565 cu-in)  
 Size: One Size
- 45**
- Weight: 0.62 kg (1.36 lb)  
 Vol: 44 L (2685 cu-in)  
 Size: One Size
- 30**
- Weight: 0.55 kg (1.22 lb)  
 Vol: 30.2 L (1845 cu-in)  
 Size: One Size



Black



Sunset



Twig

# MISSION ROVERS

These are sleek yet ample backpack suitcases to get crucial travel necessities on board for your next departure. Available in three sizes, the MISSION ROVERS are workhorse gear haulers, designed to accommodate varying loads and strategically separate your stuff.



## KEY FEATURES:

- 1 Lockable zippers
- 2 Clamshell zippered access to easily pack and organize
- 3 Large office compartment with two interior zippered mono-mesh pockets, two elastic topped drop pockets and a key clip
- 4 Exterior access laundry or shoe compartment
  - 3 way carry: Backpack, suitcase, or over shoulder
  - Three interior zippered divider pockets
  - Padded computer sleeve in office compartment fits a 15" laptop
  - Luggage handle slot on the body panel

## SPECS:

- 60 PLUS**
- Weight: 2.24 kg (4.93 lbs)  
 Vol: 59.6 L (3635 cu-in)  
 Size: One Size
- 45L**
- Weight: 1.93 kg (4.25 lbs)  
 Vol: 42 L (2565 cu-in)  
 Size: One Size
- 30L**
- Weight: 1.59 kg (3.5 lbs)  
 Vol: 29.2 L (1780 cu-in)  
 Size: One Size



Black



Shadow

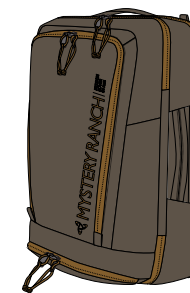

Wood Waxed



# MISSION DUFFELS

These top-of-the-line travel duffels are water-resistant, loaded with pockets and organizational options, and offer multiple ways to carry. It will be your number one travel companion.

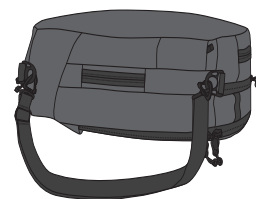
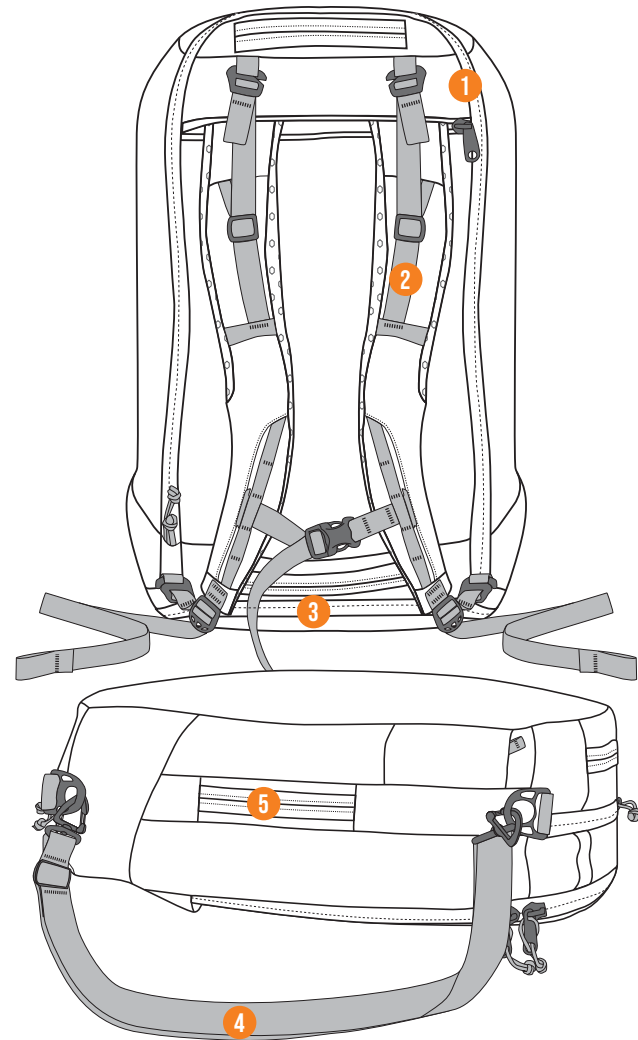

Shadow 10000

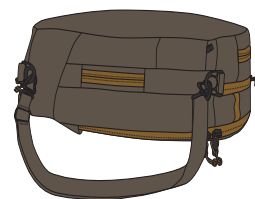

Wood Waxed

## KEY FEATURES:

- 1 Horseshoe-shaped zipper provides easy access to entire bag
- 2 Stowable shoulder pads that convert this duffel into a backpack
- 3 Exterior access laundry and shoe compartments
- 4 Removable, adjustable shoulder strap
- 5 Four exterior handles (one on each side) and four interior zipper pockets

## SPECS:

### 90

**Weight:** 1.9 kg (4.2 lbs)  
**Vol:** 93.8 L (5725 cu-in)  
**Size:** One Size  
**Color:** Shadow

### 55

**Weight:** 1.5 kg (3.4 lbs)  
**Vol:** 55 L (3355 cu-in)  
**Size:** One Size  
**Color:** Shadow, Waxed Wood

### 40

**Weight:** 1.4 kg (3.1 lbs)  
**Vol:** 41.7 L (2545 cu-in)  
**Size:** One Size  
**Color:** Shadow, Waxed Wood

# MISSION WHEELIES

Built to survive savage baggage handlers, our MISSION WHEELIES luggage collection protects your stuff on the most far-flung travels. Ample room, clever compartments, and large-diameter, off-road wheels will get you to your final destination.



## KEY FEATURES:

- 1 Exterior laundry and shoe compartments
- 2 Horseshoe-shaped zipper provides easy access to interior of the bag
- 3 Rugged, off-road wheels
- 4 Exterior front flat pocket
  - Telescoping handle
  - Four interior zipper pockets
  - ID tag pocket with easy-pull orange webbing tab

## SPECS:

### 130

**Weight:** 5 kg (11 lbs)  
**Vol:** 130 L (7935 cu-in)  
**Size:** One Size

### 80

**Weight:** 4.3 kg (9.5 lbs)  
**Vol:** 80 L (4880 cu-in)  
**Size:** One Size

### 40

**Weight:** 3.3 kg (7.3 lbs)  
**Vol:** 40 L (2440 cu-in)  
**Size:** One Size



Black

# SPIFF KITS

From dorm rooms and go bags to truck campers and hotel suites, our SPIFF KITS keep you organized and looking spiffy no matter where you're going.

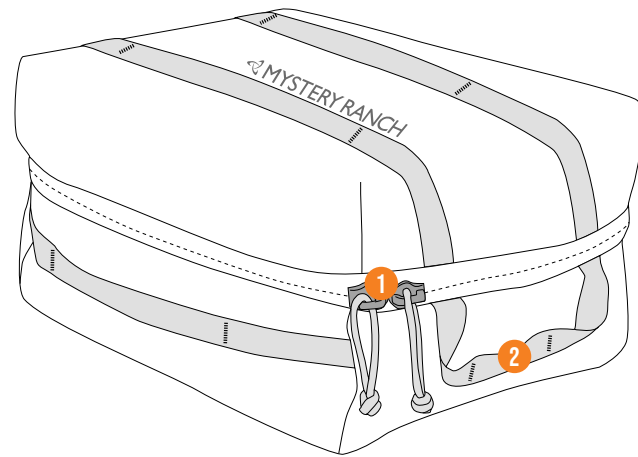

## KEY FEATURES:

- 1 Clamshell zippered access
- 2 Side handles
  - Divided zippered pockets with layered internal division and an elastic loop
  - Internal deployable swivel hook for hanging
  - Internal mesh pockets for organization
  - Fully lined for easy cleanup

## SPECS:

### LARGE

Weight: 0.3 kg (10.72 oz)  
 Vol: 6.3 L (385 cu-in)  
 Size: One Size

### SMALL

Weight: 0.13 kg (4.64 oz)  
 Vol: 6.3 L (120 cu-in)  
 Size: One Size

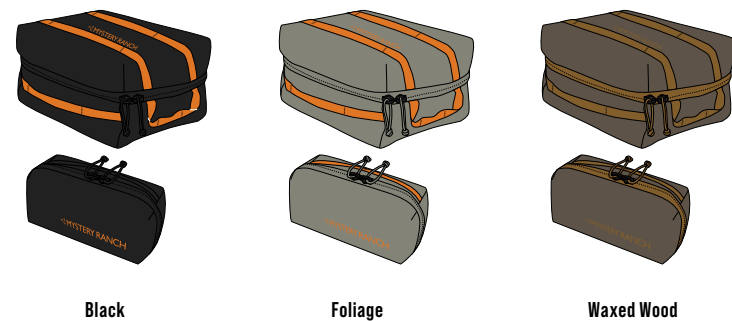

# ZOID CUBES

This cube set comes with three different sizes so you have just the right amount of storage for your next weekend getaway – whether you're traveling by plane, train, or automobile.

## KEY FEATURES:

- 1 Monomesh lid provides visibility into the bag
- 2 Handles on sides and top for easy handling while packing/unpacking
  - Designed to fit into the MYSTERY RANCH Mission Duffels, yet organizes any pack of choice

## SPECS:

### LARGE

Weight: 0.11 kg (3.84 oz)  
 Vol: 14.5 L (850 cu-in)  
 Size: One Size

### MEDIUM

Weight: 0.1 kg (3.52 oz)  
 Vol: 8.3 L (505 cu-in)  
 Size: One Size

### SMALL

Weight: 0.06 kg (2.24 oz)  
 Vol: 4 L (245 cu-in)  
 Size: One Size

### SET

ONE EACH: LARGE, MEDIUM, SMALL ZOID CUBE

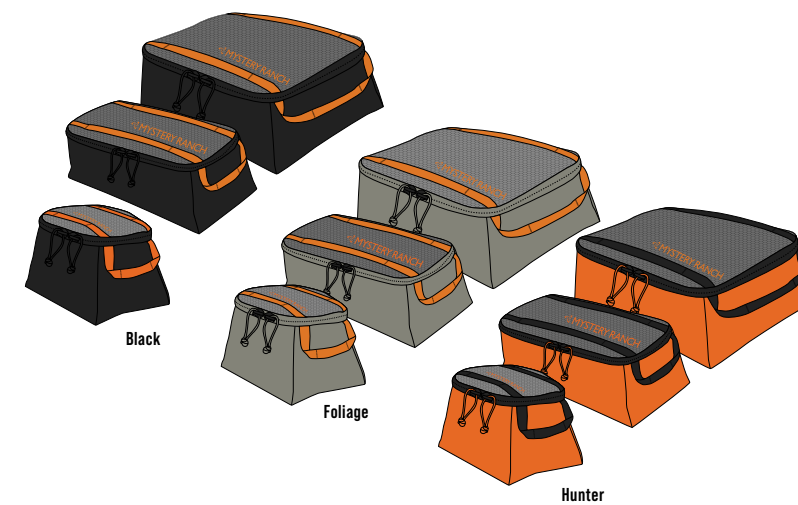
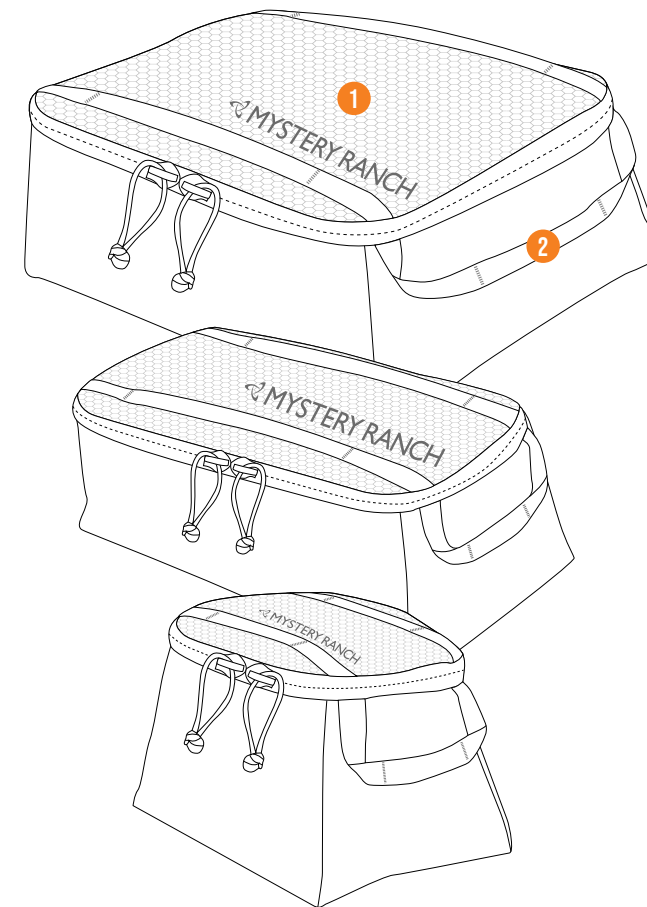





# HIGH WATER SERIES

## TECH

Built with 840D ballistic nylon with double-sided TPU coating for waterproofness, high-abrasion & tear resistance, high-temp resistance, and low-temp flexibility

TRU® Zip is the first-ever sliding, toothless, silent, dust-proof, waterproof submersible, self-healing complete zipper assembly



# WATERPROOF

**Built for the Mission also means withstanding the elements.**

This innovative series is designed as your multi-use, watertight solution. Utilizing TRU® Zip Waterproof zippers, paired with MYSTERY RANCH's ingenious construction methods and materials, this collection of packs will tolerate the most extreme elements — hail, rain, or shine.



# HIGH WATER DUFFEL

This duffel is ready for any adventure. Designed to fit perfectly on your OVERLOAD® feature of the TERRAFRAME, GUIDE LIGHT MT™ or ULTRA LIGHT MT™ frames, it can also stand alone for travel on land or water.

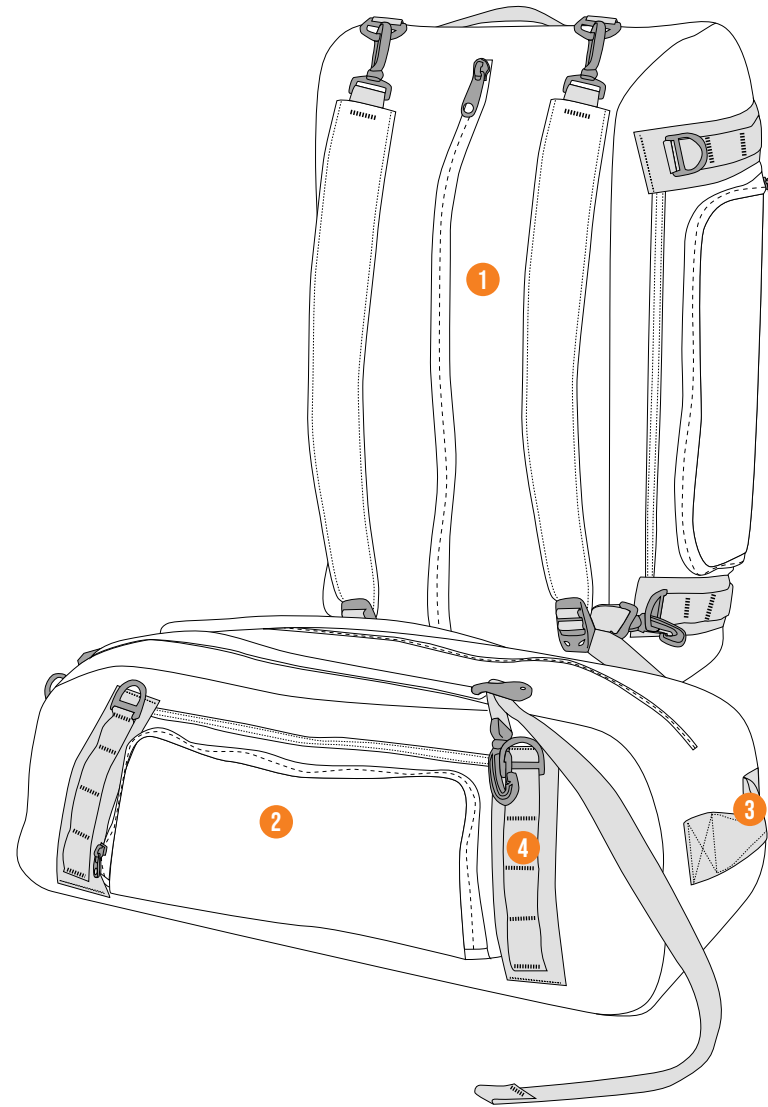

## KEY FEATURES:

- 1 Shoulder straps that can be swapped from duffel to backpack configuration
- 2 Large 3D zippered mesh side pockets
- 3 Large end handles
- 4 Heavy-duty reinforced daisy chains
  - Internal compression straps
  - Built to fit on any MR Overload® pack (Guide Light MT™, Ultra Light MT™ or Terraframe packs)

## SPECS:

Weight: 1.15 kg (2.53 lbs)  
 Vol: 52.7 L (3216 cu-in)  
 Sizes: One Size



Foliage

Forest

# HIGH WATER FLIP

Designed to keep your gear dry and ready for whatever your mission may be. The HIGH WATER FLIP pack is made for being in the office, on the trailhead, or on the water.



## KEY FEATURES:

- 1 Classic flip-top lid opening
- 2 Side to back compression straps
- 3 Fixed harnessing with padded shoulders and body panel
  - Vented lid pocket
  - Floating, padded sleeve fits laptops up to 15"

## SPECS:

Weight: 0.91 kg (2 lbs)  
 Vol: 22.9 L (1397.4 cu-in)  
 Sizes: One Size

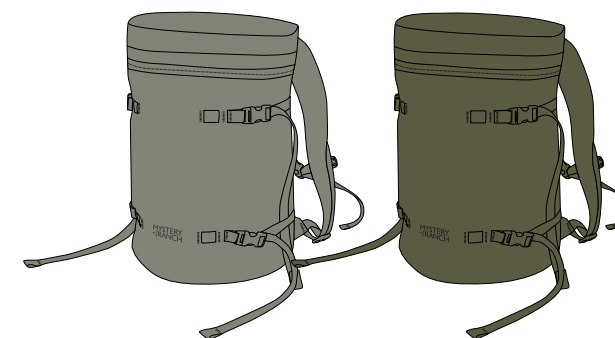

Foliage

Forest



# HIGH WATER FORAGER

A watertight accessory pocket to keep your small stuff dry and organized. On the river or caught in a storm, your small accessories will stay protected from the elements.

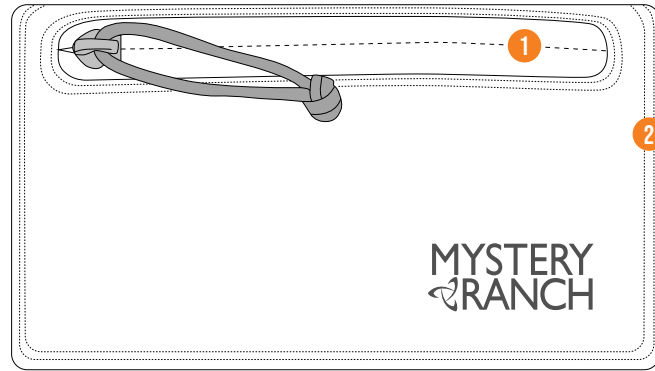

## KEY FEATURES:

- 1 TRU® Zip Waterproof zipper keeps your small items dry
- 2 RF Welded construction creates high-strength fused, leak-proof seams for total waterproofness
- 3 MOLLE attach for secure, easy access

## SPECS:

Weight: 0.05 kg (0.12 lb)  
 Vol: 1.5 L (91.5 cu-in)  
 Dims: 4.7" x 8" x 1.5"

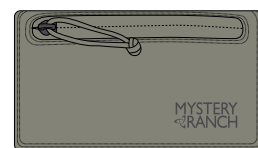
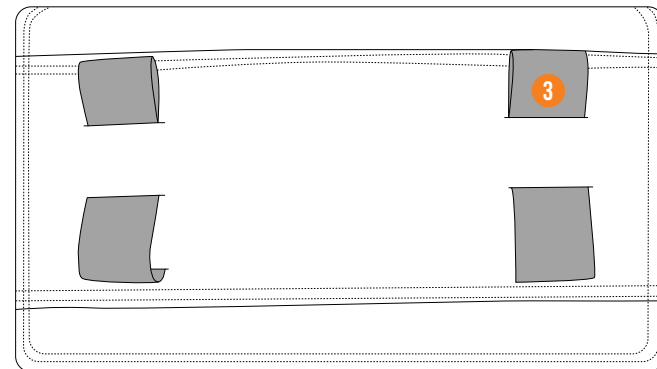

Foliage

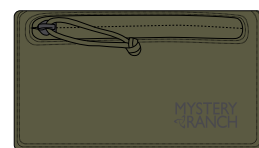

Forest

# HIGH WATER HIP PACK

This cross-over body/hip pack is perfect for any adventure that gets you out of the house. Throwing flies, floating the river, or keeping your stuff safe from spills at a concert, the HIGH WATER HIP PACK is your simple solution for ultimate protection.

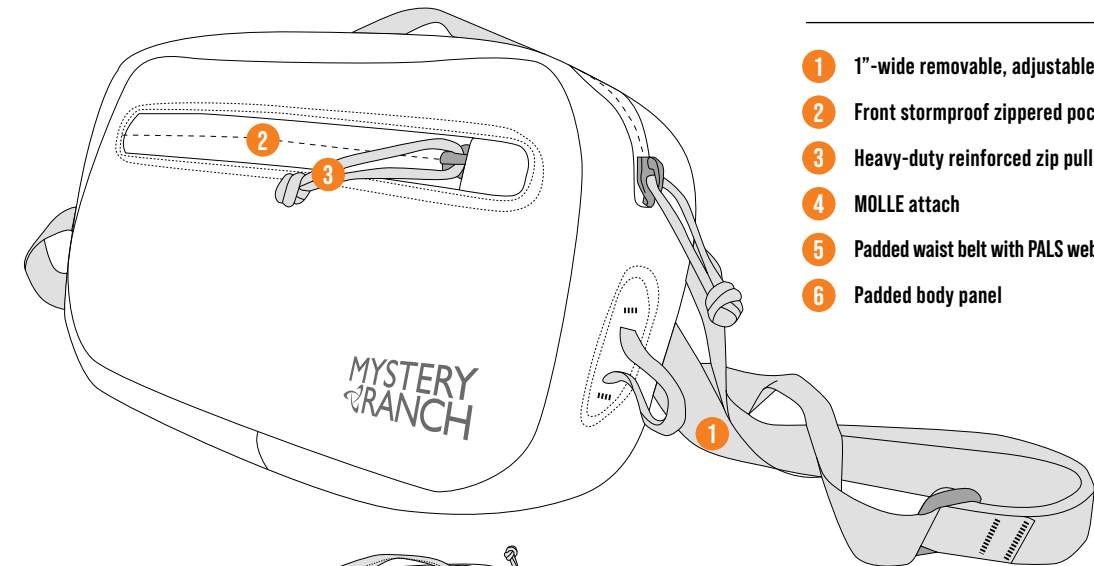

## KEY FEATURES:

- 1 1"-wide removable, adjustable shoulder strap
- 2 Front stormproof zippered pocket
- 3 Heavy-duty reinforced zip pull tabs
- 4 MOLLE attach
- 5 Padded waist belt with PALS webbing for MOLLE attach accessories
- 6 Padded body panel

## SPECS:

Weight: 0.42 kg (0.93 lb)  
 Vol: 5 L (305.1 cu-in)  
 Sizes: One Size

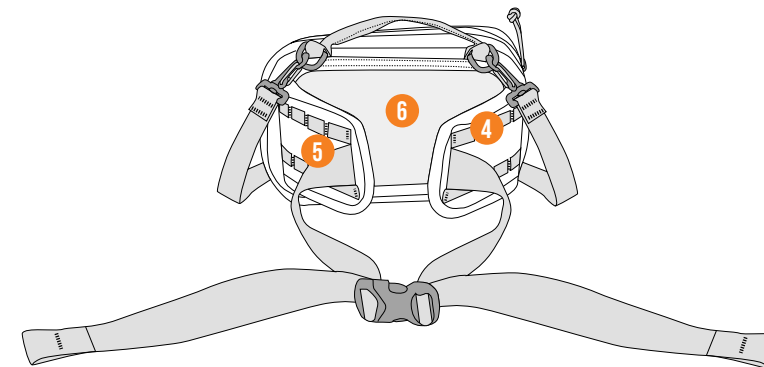

Foliage



Forest

# HIGH WATER LID

Whether stalking or just summiting, the fully waterproof HIGH WATER LID adds an extra layer of protection to the gear you need the most. This lid ensures that the gear you need stays dry – regardless of what brings you to the backcountry.

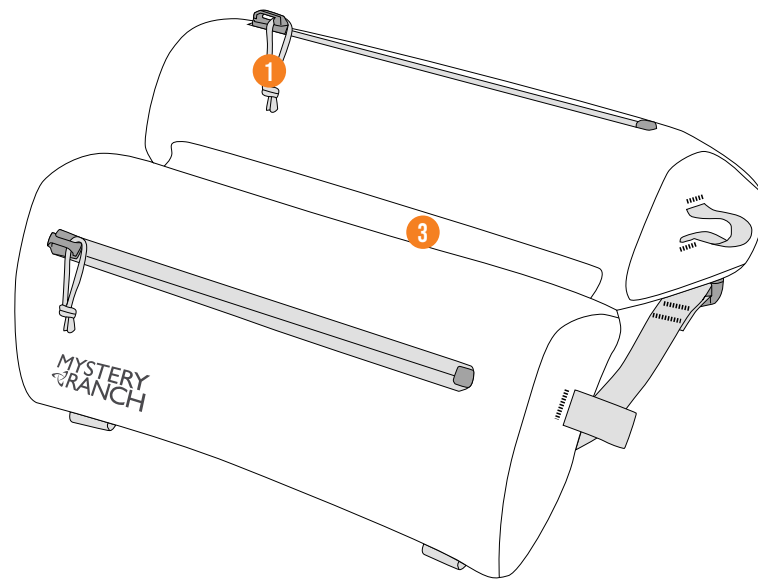

## KEY FEATURES:

- 1 Heavy-duty reinforced zip pull tabs
- 2 Removable adjustable accessory strap included
- 3 Butterfly hinge between pockets
  - Attaches to any MR Guide Light MT™ or Terraframe pack

## SPECS:

Weight: 0.33 kg (0.73 lb)  
 Vol: 8 L (488.2 cu-in)  
 Dims: 5" x 14.75" x 12.25"

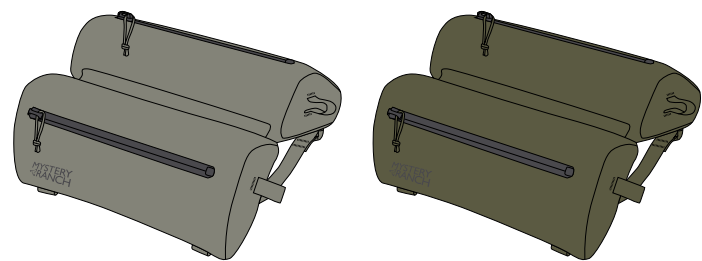
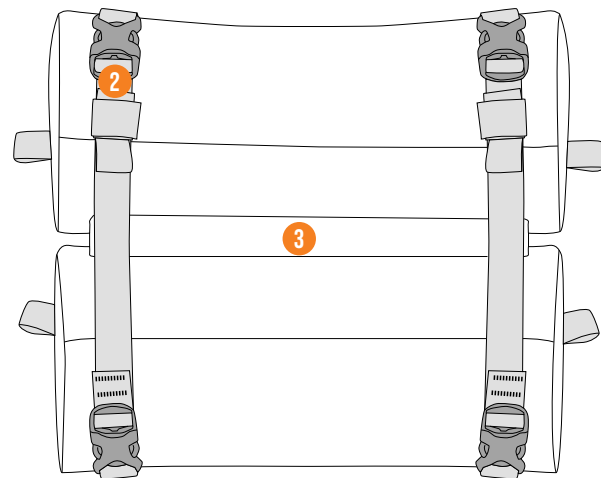

Foliage

Forest

# HIGH WATER SHOULDER BAG

A shoulder bag that allows you to go straight from the paddle board to the patio. It is totally waterproof, easily accessible, and offers reliable protection making this a multi-use, user-friendly, street-worthy bag.

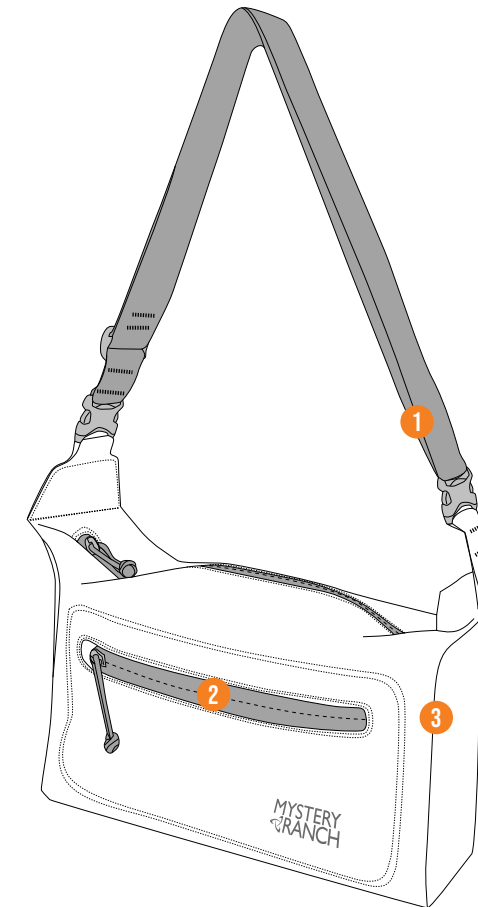

## KEY FEATURES:

- 1 1.5"-wide removable, adjustable shoulder strap
- 2 Front stormproof zippered pocket
- 3 Waterproof RF welded construction creates high-strength fused, leak-proof seams for durable, long-lasting total waterproofness
  - Heavy-duty reinforced daisy chains
  - Internal zippered pocket

## SPECS:

Weight: 0.4 kg (1 lb)  
 Vol: 9.9 L (604 cu-in)  
 Sizes: One Size



Foliage

Forest



A close-up photograph of a person wearing a blue athletic top and black gear. A white water bottle with an orange cap is secured in a black neoprene holder attached to a black strap. The holder has the 'MYSTERY RANCH' logo in orange on the front. The background is a blurred blue fabric.

# ACCESSORIES

**MYSTERY RANCH**  
accessories are designed  
to give you extra space.

We've got a wide assortment of solutions that can hold water bottles, sunglasses, and all the small, random stuff in between.



# WINGMAN MULTI POCKET

This versatile accessory teams up with your backpack to elevate your organization game, mounting on shoulder straps and offering storage that's sized just right for the small, easy-to-lose stuff.

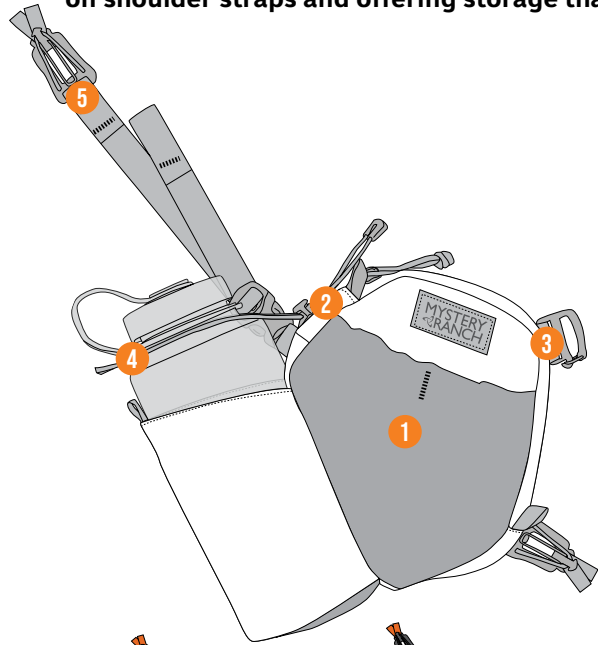

## KEY FEATURES:

- 1 Durable stretch front pocket for quick access to small items
- 2 Zippered pocket offers a secure spot for most sizes of phones, maps, keys, sunglasses, or your bird-watching journal
- 3 Easily attaches to most backpack shoulder straps
- 4 Elastic cord paired with cordlock allows for one-handed access while locking the bottle in place
- 5 Additional accessory strap allows you to convert your WINGMAN into a hip pack or over-the-shoulder sling bag.

## SPECS:

Weight: 0.13 kg (4.8 oz)  
 Vol: 1.5 L (91.5 cu-in)  
 Dims: 7.5" x 10" x 3"  
 Size: One Size

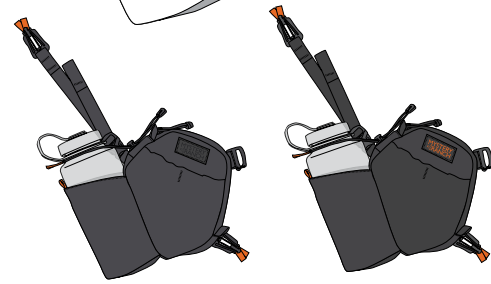

Shadow

Black

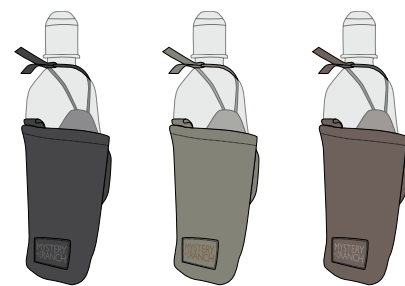

Black

Foliage

Pebble

## WINGMAN HYDRO

Weight: 0.05 kg (1.92 oz)  
 Dims: 7.25" x 4" x 0.5"  
 Size: One Size



Black

Foliage

Pebble

## WINGMAN AFP

Weight: 0.07 kg (2.56 oz)  
 Dims: 7.25" x 5" x 0.5"  
 Size: One Size

# SPIFF KITS

From dorm rooms and go bags to truck campers and hotel suites, our SPIFF KITS keep you organized and looking spiffy no matter where you're going.

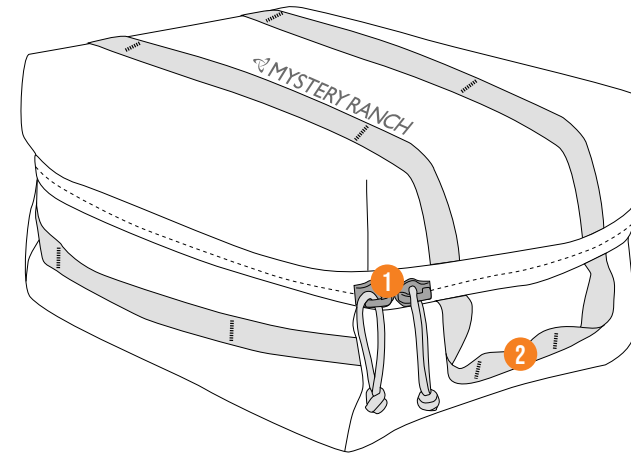

## KEY FEATURES:

- 1 Clamshell zippered access
- 2 Side handles
  - Divided zippered pockets with layered internal division and an elastic loop
  - Internal deployable swivel hook for hanging
  - Internal mesh pockets for organization
  - Fully lined for easy cleanup

## SPECS:

### LARGE

Weight: 0.3 kg (10.72 oz)  
 Vol: 6.3 L (385 cu-in)  
 Size: One Size

### SMALL

Weight: 0.13 kg (4.64 oz)  
 Vol: 6.3 L (120 cu-in)  
 Size: One Size



Black

Foliage

Waxed Wood



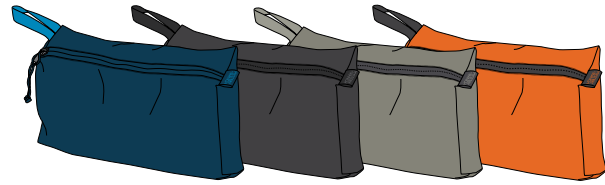

Del Mar Black Foliage Hunter

## ZOID BAG

**Weight:** 0.04 kg (1.4 oz) 0.07 kg (2.5 oz) 0.10 kg (3.5 oz)  
**Vol:** 1.5 L (92 cu-in) 3.5 L (214 cu-in) 7 L (427 cu-in)  
**Dims:** 6.5" x 9" x 2" 6.5" x 11.5" x 3.5" 7.5" x 15" x 5.5"

**Sizes:** S M L

**Set:** Includes one size of each

All sizes come in Del Mar, Black, Foliage, & Hunter



Coyote



Foliage

## QUICK ATTACH ACCESSORY STRAPS

**Volume:** 0.06 kg (2.2 oz)  
**Size/Dims:** One size — 2 per pack (1" x 24")



Foliage Buckskin Black Hunter Ponderosa Gravel

## TECH HOLSTER

**Weight:** 0.1 kg (3.2 oz)  
**Vol:** Fits most phones  
**Dims:** 7" x 4.5" x 2"

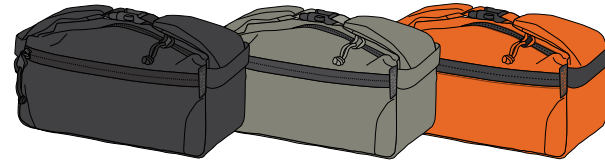

Black Foliage Hunter

## ZOID CELL

**Weight:** 0.03 kg (10.5 oz)  
**Vol:** 4 L (244 cu-in)  
**Size/Dims:** One Size (6" x 12.5" x 6")



Black

## THREAD BED

**Weight:** 0.18 kg (6.34 oz)  
**Vol:** 10 Ice screws  
**Size:** One Size



Black Foliage

## DSLR CHEST RIG

**Weight:** 0.5 kg (17.6 oz)  
**Vol:** 3 L (185 cu-in)  
**Size/Dims:** One Size (9.3" x 7.3" x 6.3")



Shadow



Black

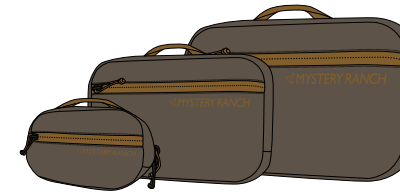

Wood Waxed



Black

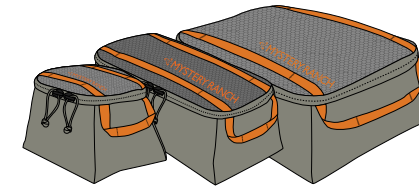

Foliage

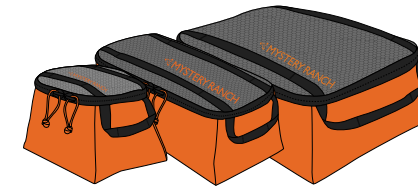

Hunter

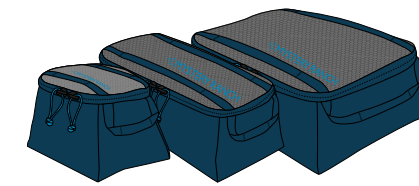

Del Mar

## MISSION CONTROLS

### LARGE

**Weight:** 0.31 kg (10.9 oz)  
**Vol:** 4 L (245 cu-in)  
**Size:** One Size

### MEDIUM

**Weight:** 0.26 kg (9.2 oz)  
**Vol:** 2.5 L (155 cu-in)  
**Size:** One Size

### SMALL

**Weight:** 0.13 kg (4.5 oz)  
**Vol:** 1.5 L (90 cu-in)  
**Size:** One Size

## ZOID CUBES

### LARGE

**Weight:** 0.11 kg (0.24 lb)  
**Vol:** 14.5 L (879 cu-in)  
**Size:** One Size

### MEDIUM

**Weight:** 0.1 kg (0.22 lb)  
**Vol:** 8.3 L (506 cu-in)  
**Size:** One Size

### SMALL

**Weight:** 0.06 kg (0.14 lb)  
**Vol:** 4 L (244 cu-in)  
**Size:** One Size

### SET

INCLUDES ONE EACH: Large, Medium, Small

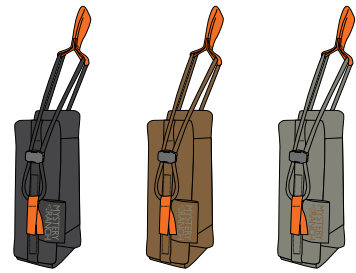

Black Coyote Foliage

## BEAR SPRAY HOLSTER

**Weight:** 0.06 kg (2 oz)  
**Vol:** Canisters from 7.9 oz - 13.4 oz from all major manufacturers

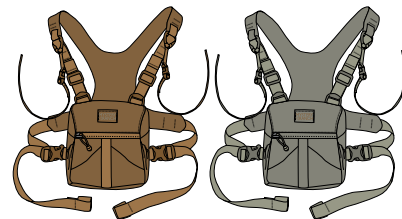

Coyote Foliage

## BINO HARNESS 10X

**Weight:** 0.31 kg (10.88 oz)  
**Vol:** Fits most 10x binoculars [height 6.75" or less]  
**Dims:** 7" x 8" x 4.3"  
**Sizes:** Regular, XL

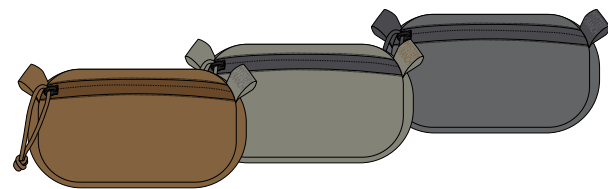

Coyote Foliage Shadow

## FORAGER POCKET

**Weight:** 0.07 kg (2.5 oz) 0.08 kg (2.8 oz)  
**Vol:** .75 L (46 cu-in) 1 L (61 cu-in)  
**Sizes:** S L

All sizes come in Coyote, Foliage, & Shadow

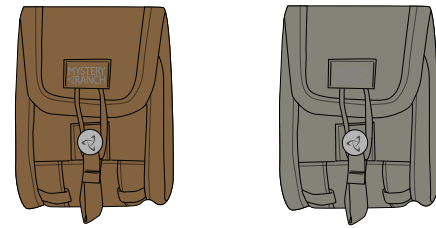

Coyote Foliage

## RANGEFINDER HOLSTER

**Weight:** 0.05 kg (1.6 oz)  
**Size:** Fits most rangefinders  
**Dims:** 5" x 3.5" x 1.5"

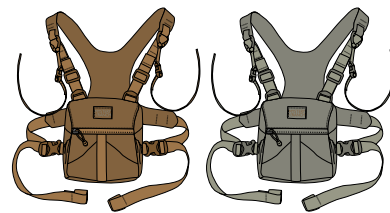

Coyote Foliage

## BINO HARNESS 12X

**Weight:** 0.32 kg (11.36 oz)  
**Vol:** Fits most 12x binoculars [height 6.75"-8"]  
**Dims:** 9" x 8" x 3.8"  
**Sizes:** Regular, XL



Foliage Black Hunter

## QUICK ATTACH ZOID BAG

**Weight:** 0.06 kg (2.08 oz) 0.08 kg (2.88 oz)  
**Vol:** 1.5 L (91.5 cu-in) 3 L (183 cu-in)  
**Dims:** 8.5" x 5.5" x 3.5" 13.25" x 5.5" x 3.5"  
**Sizes:** S M

# SUPER FLY PACK COVER

For those who don't like risking their luck when there's a chance of rain, the SUPER FLY boasts taped seams and 2.5x fabric for a top-notch waterproofing experience.

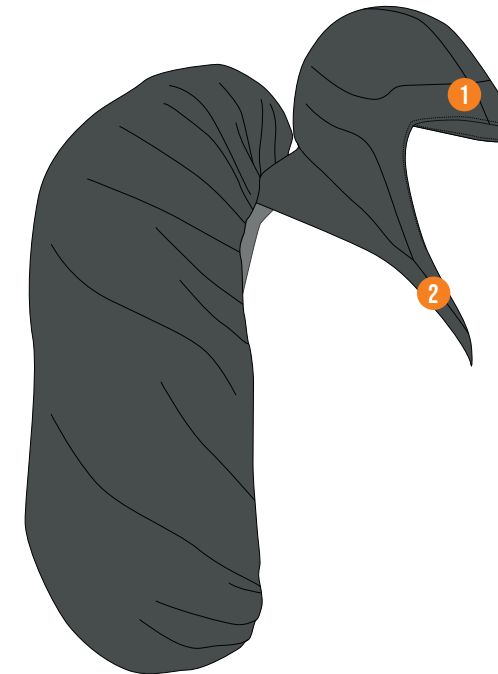

Mineral Gray

### KEY FEATURES:

- 1 Pack cover with an adjustable hood
- 2 Attaches to most backpack shoulder pads
  - Taped seams ensure 100% water protection
  - Stores conveniently in the attached stuff sack
  - High-quality 2.5x layer Nylon waterproof, breathable fabric

### SPECS:

**Large Fits:** 60 L to 105 L packs  
**Medium Fits:** 40 L to 60 L packs  
**Small Fits:** 20 L to 40 L packs



Black Orange



Shadow

## PACK FLY

**Weight:** 0.09 kg (3 oz) 0.11 kg (3.7 oz) 0.15 kg (5 oz)  
**Vol:** 25 L - 45 L 45 L - 70 L 70 L - 105 L  
**Sizes:** S M L

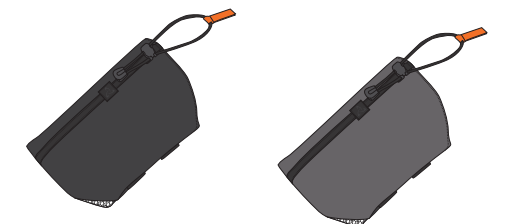

Black

Shadow

## REMOVABLE WATER BOTTLE POCKET

**Weight:** 0.1 kg (3.2 oz)  
**Size/Dims:** One Size (7" x 4" x 4")



# LOGOWEAR

Show you belong to the  
**MYSTERY RANCH** pack.

Our logowear collection showcases original MYSTERY RANCH artwork not found anywhere else. At home, in the city, or the wild, they are the perfect way to show your MR love.



NEW

# MR LOGO



Black

### KEY FEATURES:

- MYSTERY RANCH logo
- Screen printed design
- Center chest placement
- 52% Cotton 48% Polyester

### SPECS:

Size: S M L XL XXL



Oatmeal Heather



Stone Heather



Sailor Blue Heather

NEW

# MR LOGO HOODIE



Grey Heather

### KEY FEATURES:

- MYSTERY RANCH logo
- Screen printed design
- Center chest placement
- 75% Cotton/ 25% Polyester

### SPECS:

Size: S M L XL XXL



Black



NEW

# CERVALCES SCOTTI



Black

**KEY FEATURES:**

- Hand illustrated by Bozeman artist
- Screen printed design
- 52% Cotton, 48% Polyester
- Center chest and back collar placement

**SPECS:**

Size: S M L XL XXL



Military Heather

NEW

# MEGALOCEROS GIGANTEUS



Stone Heather

**KEY FEATURES:**

- Hand illustrated by Bozeman artist
- Screen printed design
- 52% Cotton, 48% Polyester
- Left chest and full back placement

**SPECS:**

Size: S M L XL XXL



Black

NEW

# MR BRAND SEAL



Black

### KEY FEATURES:

- Designed in Bozeman
- Screen printed design
- 52% Cotton, 48% Polyester
- Center chest placement

### SPECS:

Size:  S  M  L  XL  XXL



Sailor Blue Heather

NEW

# MR SPEED GOAT RIG



Military Heather

### KEY FEATURES:

- Hand illustrated by Bozeman artist
- Screen printed design
- 52% Cotton, 48% Polyester
- Center chest and back collar placement

### SPECS:

Size:  S  M  L  XL  XXL



Oatmeal Heather



NEW

# PACK SCENERY



Oatmeal Heather

### KEY FEATURES:

- Hand illustrated by Bozeman artist
- Screen printed design
- 52% Cotton, 48% Polyester
- Full front placement

### SPECS:

Size:  S  M  L  XL  XXL



Sailor Blue Heather

NEW

# TOOLS IN THE ROUND



Black

### KEY FEATURES:

- Screen printed design
- 52% Cotton, 48% Polyester
- Left chest and upper back placement

### SPECS:

Size:  S  M  L  XL  XXL



Oatmeal Heather

NEW

# LOGO FRONT TRUCKER HAT



Buckskin

### KEY FEATURES:

- 1 Stiff mesh back
- 2 Cotton fabric brim

### SPECS:

Size: One Size



Black

NEW

# MR BRAND SEAL HAT



Black

### KEY FEATURES:

- 1 Stiff mesh back
- 2 Cotton front and brim

### SPECS:

Size: One Size



Forest



NEW

# MR CAMP HAT



Black

### KEY FEATURES:

- 1 Cotton Twill front and brim
- 2 Full fabric back
- Unstructured Dad Hat

### SPECS:

Size: One Size



Tiger's Eye

NEW

# MR SCRIPT CORDUROY HAT



Indigo

### KEY FEATURES:

- 1 Corduroy Hat
- 2 Full fabric back

### SPECS:

Size: One Size



Shadow

NEW

# SPINNER RUNNING HAT



Paprika

### KEY FEATURES:

- 1 Foam front
- 2 Soft foam brim
- 3 Soft mesh back

### SPECS:

Size: One Size

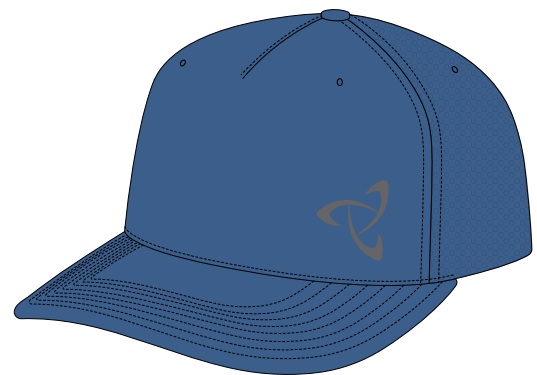

Pacific

NEW

## LET'S GO HIKE PATCH



## MYSTERY BISCUIT PATCH



## A-SIDE SPECIAL BLEND PATCH

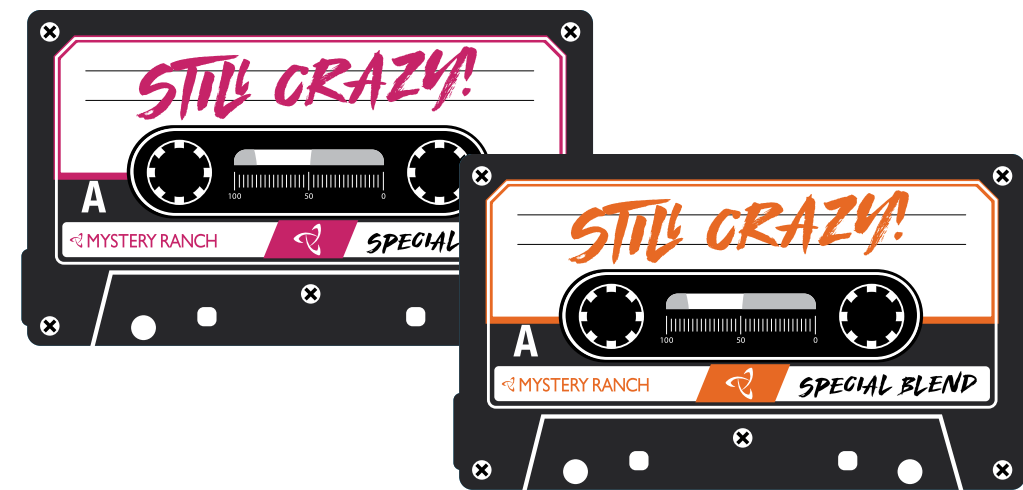



# FITTING & SIZING

## Getting Your Size

The key to a comfortable pack load is a properly fitting backpack. We've designed a more custom fit into our packs with simple sizing based off two measurements. To find the appropriate size waist and yoke for your pack, collect the following two measurements, then reference the sizing chart below.

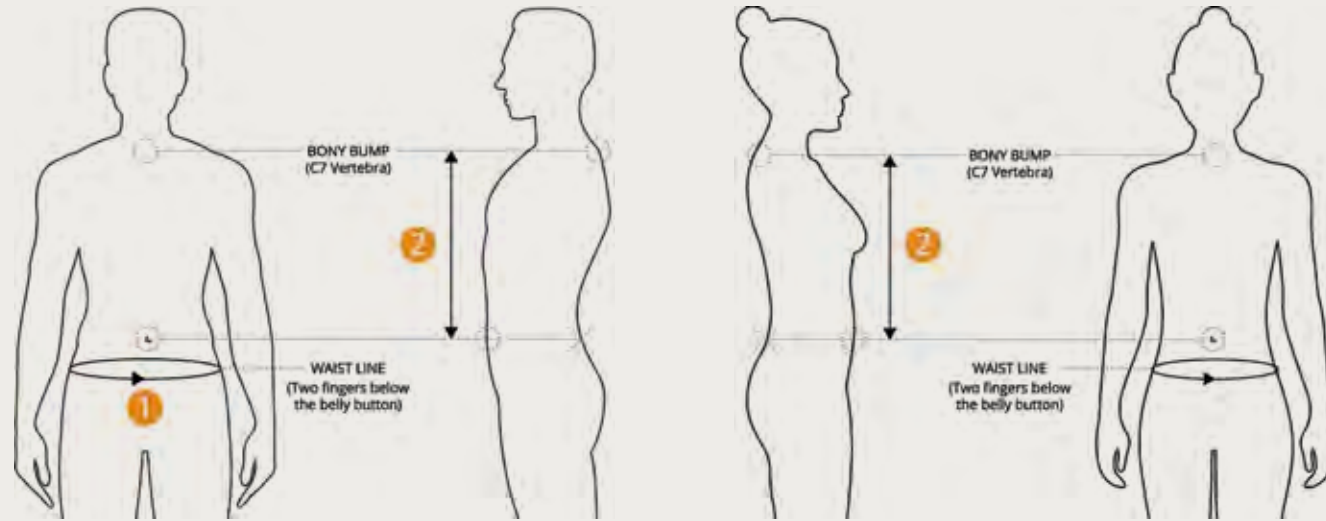

### Torso

Use a tailors tape measure or string and have a friend measure between the bony bump at the base of your neck (C7 vertebra) to the spot on your spine that is just behind your belly button.

### Waist Circumference

Measure around your waist just above the top of your hip bones (roughly two fingers below your belly button).

#### Men's/Unisex Framed Sizing

	S	M	L	XL	One Size (OS)
Torso	15 - 20 in 38 - 51 cm	15 - 20 in 38 - 51 cm	17 - 24 in 43 - 61 cm	17 - 24 in 43 - 61 cm	16 - 22 in 41 - 56 cm
Waist	26 - 32 in 66 - 81 cm	31 - 36 in 79 - 92 cm	35 - 40 in 89 - 102 cm	39+ in 100+ cm	30 - 40 in 76 - 102 cm

#### Women's Framed Sizing

	XS	S	M	L	One Size (OS)
Torso	13 - 18 in 33 - 46 cm	13 - 18 in 33 - 46 cm	16 - 22 in 41 - 56 cm	16 - 22 in 41 - 56 cm	16 - 22 in 41 - 56 cm
Waist	26 - 32 in 66 - 81 cm	31 - 36 in 79 - 92 cm	35 - 40 in 89 - 102 cm	39+ in 100+ cm	30 - 40 in 76 - 102 cm

# WARRANTY & REPAIRS



MYSTERY RANCH designs and manufactures packs for the job that needs to get done, supporting customers who rely on our packs to get home at the end of the day. Our Warranty guarantees everything we build against defects in materials and craftsmanship for the practical lifetime of the product. We will happily offer repair or replacement for issues with materials or craftsmanship. Damage due to normal wear and tear or misuse can be repaired for a reasonable charge.

# PATENTS

Most MYSTERY RANCH products are covered by US and Foreign Patents, and other Patents Pending.

US Patents include:

US 6,626,342 B1; US 7,673,777 B2; US 8,381,956 B2; US 8,561,866 B2; US 8,950,644 B2; US 8,348,114 B2; US 8,579,171 B2; US 9,173,473 B2; US 9,271,559 B2; US 8,162,194 B2 ; US 8,955,792 B2

# CERTIFICATIONS

MYSTERY RANCH maintains an ISO 9001:2015 Quality Management System.



**MYSTERY RANCH BACKPACKS**

1750 Evergreen Drive  
Bozeman, MT 59715  
833-548-1999

[mysteryranch.com](https://mysteryranch.com)

